

MHI
Copy 3

~~RESTRICTED~~
UNCLASSIFIED FM 18-15

Supervisor's copy

WAR DEPARTMENT

TANK DESTROYER FIELD MANUAL

TANK DESTROYER DRILL AND
CREW DRILL

3-INCH GUN MOTOR CARRIAGE M10
76-MM GUN MOTOR CARRIAGE T70
3-INCH TOWED GUN (GUN M5
AND CARRIAGE M1)

4 December 1943

REGRADED UNCLASSIFIED BY
AUTHORITY OF
DOD DIR. 5200.1-R
ON 05/22/83

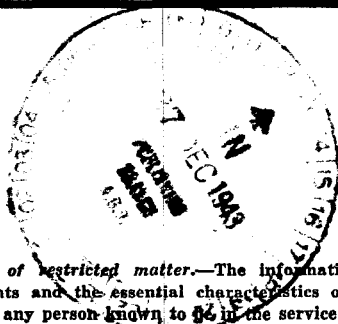

Dissemination of restricted matter.—The information contained in restricted documents and the essential characteristics of restricted material may be given to any person known to be in the service of the United States and to persons of undoubted loyalty and discretion who are cooperating in Government work, but will not be communicated to the public or to the press except by authorized military public relations agencies. (See also par. 186, AR 60-5, 28 Sep 1942.)

RES C I N D E D

~~RESTRICTED~~

FM 18-15

TANK DESTROYER FIELD MANUAL



TANK DESTROYER DRILL AND CREW DRILL

3-INCH GUN MOTOR CARRIAGE M10
76-MM GUN MOTOR CARRIAGE T70
3-INCH TOWED GUN (GUN M5
AND CARRIAGE M1)



Dissemination of restricted matter.—The information contained in restricted documents and the essential characteristics of restricted material may be given to any person known to be in the service of the United States and to persons of undoubted loyalty and discretion who are cooperating in Government work, but will not be communicated to the public or to the press except by authorized military public relations agencies. (See also par. 18b, AR 380-5, 28 Sep 1942.)

UNITED STATES
GOVERNMENT PRINTING OFFICE
WASHINGTON : 1943

WAR DEPARTMENT,
WASHINGTON 25, D. C., 4 December 1943.

FM 18-15, Tank Destroyer Drill and Crew Drill, 3-Inch Gun Motor Carriage M10, 76-mm Gun Motor Carriage T70, 3-Inch Towed Gun (Gun M5 and Carriage M1), is published for the information and guidance of all concerned.

[A. G. 300.7 (3 Nov 43).]

BY ORDER OF THE SECRETARY OF WAR:

G. C. MARSHALL,
Chief of Staff.

OFFICIAL:

J. A. ULIO,
Major General,
The Adjutant General.

DISTRIBUTION:

D 2, 7, 17 (5); R 18 (2); Bn 18 (2); C 18 (20).
(For explanation of symbols see FM 21-6.)

TABLE OF CONTENTS

| | Paragraphs | Page |
|--|------------|------|
| CHAPTER 1. General. | | |
| SECTION I. General----- | 1-2 | 1 |
| II. Commands and methods of trans- mission----- | 3-6 | 2 |
| CHAPTER 2. Training for placing weapons in action. | | |
| SECTION I. Elementary training----- | 7-11 | 14 |
| II. Advanced training----- | 12-17 | 23 |
| CHAPTER 3. 3-inch gun motor carriage M10 and M10A1. | | |
| SECTION I. Mechanical training----- | 18-20 | 28 |
| II. Training for placing in action--- | 21-33 | 30 |
| CHAPTER 4. 76-mm gun motor carriage T70. | | |
| SECTION I. General----- | 34 | 41 |
| II. Training for placing in action--- | 35-55 | 41 |
| CHAPTER 5. Training for placing antiaircraft ma- chine gun in action----- | 56-63 | 62 |
| CHAPTER 6. 3-inch towed gun (gun M5 and gun carriage M1). | | |
| SECTION I. General----- | 64-66 | 69 |
| II. Training for placing in action--- | 67-84 | 70 |
| III. Duties in firing----- | 85-94 | 84 |
| CHAPTER 7. Combat formations----- | 95 | 94 |
| CHAPTER 8. Ceremonies and inspections. | | |
| SECTION I. General----- | 96-97 | 101 |
| II. Reviews and other ceremonies--- | 98-109 | 101 |
| III. Inspections----- | 110-113 | 110 |
| APPENDIX | | |
| I. Inspection routine, 76-mm gun motor carriage T70----- | | 116 |
| II. Destruction of matériel----- | | 120 |
| INDEX----- | | 129 |

TANK DESTROYER FIELD MANUAL

TANK DESTROYER DRILL AND CREW DRILL

3-INCH GUN MOTOR CARRIAGE M10

76-MM GUN MOTOR CARRIAGE T70

3-INCH TOWED GUN (GUN M5 AND CARRIAGE M1)

CHAPTER 1

GENERAL

Paragraphs

| | |
|---|-----|
| SECTION I. General | 1-2 |
| II. Commands and methods of transmission..... | 3-6 |

SECTION I

GENERAL

■ 1. SCOPE.—*a.* The primary purpose of drill is to perfect means and methods for maneuvering and fighting troops on the battlefield. This must be continually kept in mind. The drill prescribed herein may be adapted to any type of tank destroyer unit. Explanations are of a general nature which give sufficient latitude for adaptation to specific units. All concerned should use this manual as a guide to common-sense solution of minor points which are not specifically covered in the text. Discussion over trifles or failure to make appropriate adaptation indicates a failure to grasp the spirit of the regulations. Commanders should encourage subordinates to make minor adjustments without requesting an interpretation. Necessary adaptation should not complicate the drill.

b. The diagrams herein are based on a general type of organization. They may be adapted to any type of unit, to changes in tables of organization and strength, and to the maneuver space available.

c. Drill.—The procedures, formations, and movements for mounted and dismounted drill and for ceremonies and inspections are prescribed in FM 22-5, and in this manual. Drill for the light armored car M-8 is prescribed in FM 2-6 (when published).

d. Duties of the driver are covered in FM 25-10 and in this manual.

e. Training for placing the destroyer and antiaircraft guns in action is prescribed in this manual.

■ 2. DEFINITIONS.—For definitions see FM 22-5.

SECTION II

COMMANDS AND METHODS OF TRANSMISSION

■ 3. COMMANDS.—*a.* The commands authorized for tank destroyer units and the manner of giving them are prescribed in FM 22-5, FM 25-10, TM 10-460, and in this manual.

b. Commands may be transmitted by the following methods:

(1) Audible signals (voice, interphone, whistle, trumpet, siren, gunfire).

(2) Touch signals.

(3) Visual signals (arm, disk, flag, lights, pyrotechnics).

(4) Example of the leader.

(5) Radio.

(6) Staff officers.

(7) Messengers.

■ 4. AUDIBLE SIGNALS.—*a. Voice.*—Communication between vehicles by voice is seldom practicable.

b. Interphone.—If equipped with interphone, this method of communication between crew members should be used whenever the vehicle is operated.

c. Whistle.—The following signals can be made with the whistle, siren, vehicle horn, or trumpet:

(1) One short blast..... ATTENTION TO ORDERS.

(2) One long blast..... CEASE FIRING.

(3) Three blasts repeated several times..... AIR ATTACK OR MECHANIZED ATTACK.

■ 5. TOUCH SIGNALS.—Touch signals may be used by a destroyer commander to direct the driver. They are given with the foot or hand.

a. *Move forward.*—Several taps between the shoulder blades.

b. *Increase speed.*—Repeat “move forward” signal more rapidly. The taps are continued until the desired speed is attained.

c. *Decrease speed or halt.*—Steady pressure between the shoulder blades. Pressure is continued until the desired reduced speed is attained or the vehicle is halted.

d. *Move in reverse.*—Tap repeatedly on the back of the driver’s head (helmet).

e. *Change direction.*—Press on the driver’s right (left) shoulder to turn right (left). The driver continues turning until pressure ceases.

■ 6. VISUAL SIGNALS.—a. *Arm and hand signals.*—Arm and hand signals are used for drill, extended order, and control of fire and movement in combat. (See figs. 1 to 8, inclusive.)

(1) Unless otherwise prescribed, signals are given with the right arm and hand.

(2) The recipient of a signal may be required to repeat the signal to show that it is understood. If the return signal is in error, the leader, after signaling “Disregard,” will repeat the correct signal.

(3) All vehicle commanders are responsible for relaying signals to vehicles in *rear* or to a *flank*. Certain types of vehicles are constructed so that the vehicle commander’s signals are not readily visible. Under such conditions, the commander may require another member of the crew to relay signals, the commander checking to see that the relay is properly executed.

(4) Commands may be given by combining signals. For example, the command PLATOON COLUMN may be transmitted by signaling “Platoon” followed by “Column.”

(5) Range of visibility of arm signals may be increased by the use of disks. Signal flags are used for control and transmission of commands. Their use is limited to important signals where a positive visual method is desired. They

should be supplemented when practicable by other means such as the radio. Each combat vehicle is equipped with three solid color flags; orange, red, and green. They are displayed vertically from the highest point of the vehicle to indicate the following:

- (a) Enemy in sight—Red.
- (b) All clear, ready, or understood—Green.
- (c) Disregard or vehicle out of action—Orange.
- (d) Assemble or close—Orange and green.
- (e) Extend—Red and orange.
- (f) Disperse—Red and green.
- (g) Gas—Red, orange, and green.

(6) Signals most commonly used by tank destroyer units which are not prescribed herein will be found in FM 22-5, TM 10-460, and FM 29-5. Additional signals are—

(a) *Column*.—Extend the arm vertically, repeatedly swinging arm forward to the horizontal and upward and back beyond the verticle several times.

(b) *Disregard*.—Place the hand against the back at the height of the waist, back of the hand toward the body.

(c) *Echelon right (left)*.—Extend the right (left) arm upward to the side at an angle of 45° above the horizontal, repeating several times.

(d) *Extend*.—Extend the arms vertically overhead, palms together, and swing them downward to the horizontal position. Repeat several times. When a formation possesses both width and depth, extension is made in both directions.

(e) *Irregular column (echelon) (wedge)*.—Extend both arms fully to the front, palms in; move them upward and downward in a chopping motion, swinging the arms together to the right and left; follow with signal for column (echelon) (wedge).

(f) *Line*.—Raise the hand vertically to the full extent of the arm, fingers extended and joined, and wave the arm well down alternately to the right and left several times.

(g) *Close up*.—Extend the arms horizontally sideward, palm of the hands up, and swing them upward to the vertical position overhead until palms meet. Repeat several times.

(h) "V".—Extend arms overhead, forming a large V.

b. Command signals.—Commands and information frequently are transmitted by signals. Signals most commonly used by tank destroyer units are shown in figures 1 to 5, inclusive. The signal for the command of execution, if such is necessary, consists in extending the arm vertically and then lowering it sharply to the side.

c. Driver's arm signals.—Traffic signals should be made clearly and given in time to afford ample warning to drivers of other vehicles. (See figs. 6 and 7.)

d. Guide signals.—See figure 8 for signals for maneuvering vehicles in a confined space and when the driver is unable to see to the rear or to the flank. The vehicle commander or other crew member should place himself within sight of the driver and assist the driver by giving the appropriate signal. Dismounted signals are found in FM 22-5 and TM 10-460. Additional signals are:

(1) *Move in reverse.*—Extend arm and hand, palm toward driver, make pushing motion. Repeat several times until vehicle has moved to desired position.

(2) *Change direction.*—Execute short outward thrust of fist in direction desired until the vehicle has reached the proper direction. This signal is used for either backing or leading a vehicle.

(3) *Close up or caution.*—Extend hands forward, with palms separated to indicate clearance, and bring palms toward each other until they meet at the instant it is desired to stop the vehicle. (Use for gauging distance in confined space.)

e. Light signals.—(1) For night traffic control lights, see FM 29-5.

(2) In giving signals described below, face toward those who are to receive the signal. Hold and move the light horizontally. Do *not* point it upward. When giving light signals under blackout conditions, use a light the lens of which has been covered with suitable colored material. Subordinate leaders repeat signals and pass them along the column.

(3) The following light signals are prescribed for general traffic control:

(a) *Right or left turn.*—Rotate the light in a vertical plane, describing circles about 12 to 18 inches in diameter so that the light, at the *top* of the circle, travels in the direction of the desired turn. (See FM 29-5.)

(b) *Start engine.*—Rotate light, describing circles to simulate cranking.

(c) *Stop, or stop engine.*—Move light back and forth horizontally and repeat as necessary.

(d) *Forward, move out, go, or increase speed.*—Move the light up and down in a vertical line, repeating as necessary.

(4) The following signals are prescribed when a dismounted man signals to maneuver individual vehicles:

(a) *Move forward, stop, turn, and start or stop engine.*—Same as prescribed in (3) above.

(b) *Move in reverse.*—Steady light held still and pointed toward the driver.

NOTE.—After the movement of a vehicle has started, when the driver cannot see the light, he must stop his vehicle.

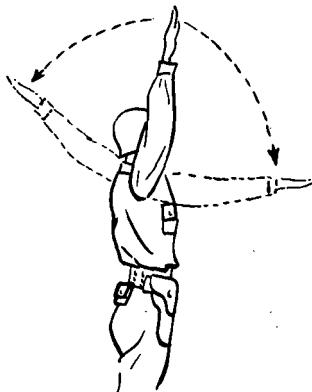

COLUMN

FIGURE 1.—Arm and hand signals.

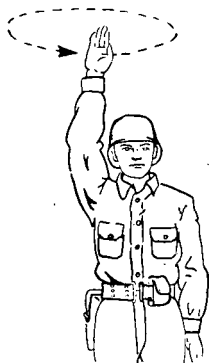

ASSEMBLE

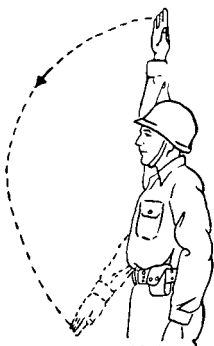

**FIRE
FIRE ONE ROUND**

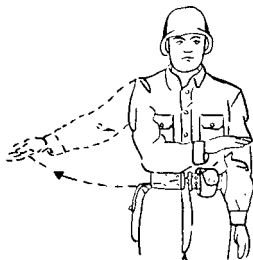

**COMMENCE FIRING
FIRE FASTER
FIRE SLOWER**



**ARE YOU READY?
OR, I AM READY**

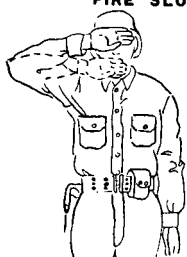

CEASE FIRING



LEADERS JOIN ME

FIGURE 2.—Arm and hand signals.

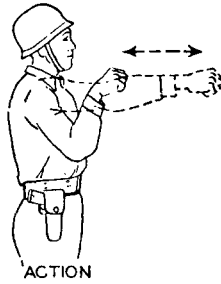
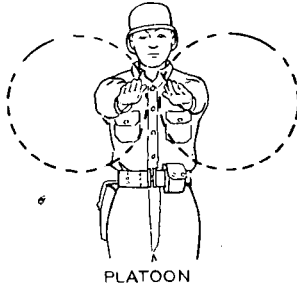
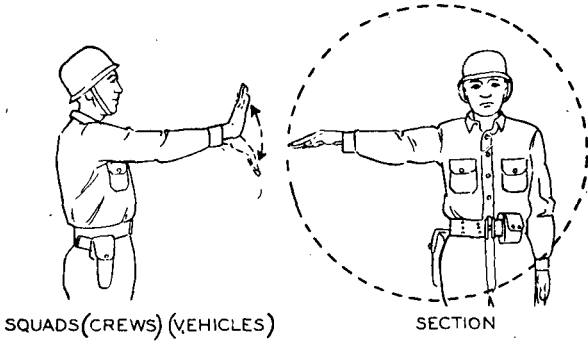

FIGURE 3.—Arm and hand signals.

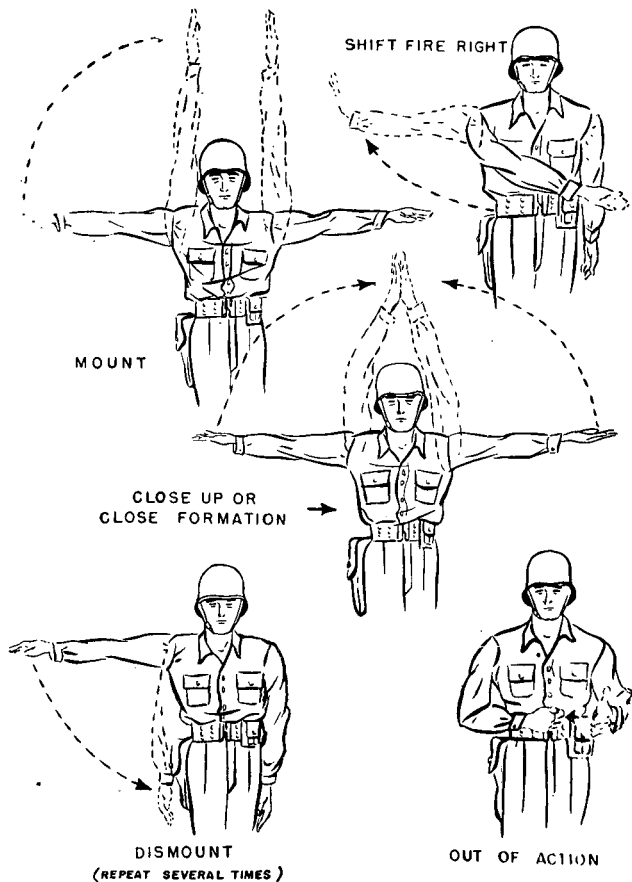

FIGURE 4.—Arm and hand signals.

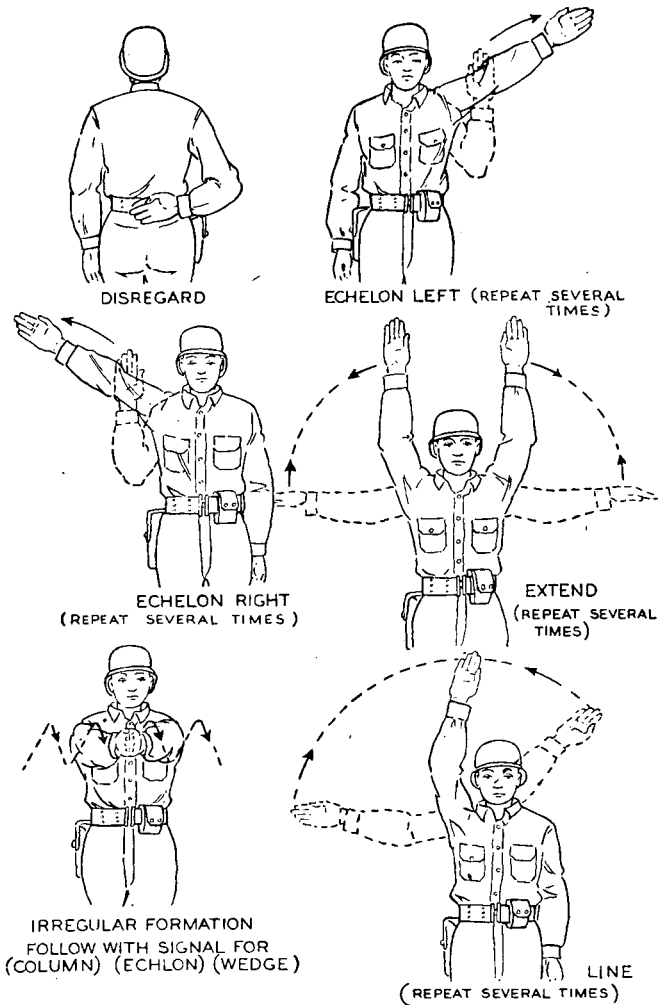
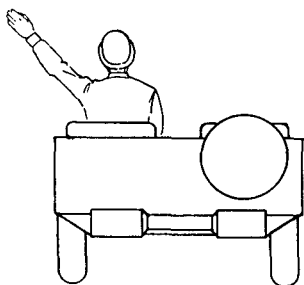
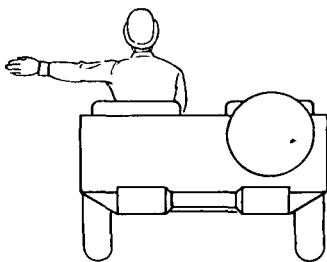

FIGURE 5.—Arm and hand signals.



TURN RIGHT



TURN LEFT

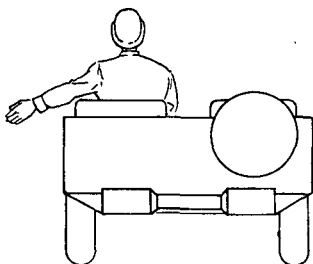

SLOW OR STOP

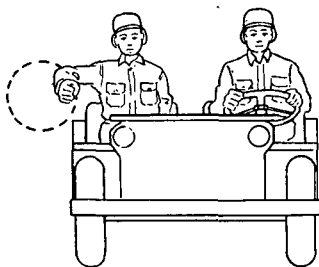

START ENGINE

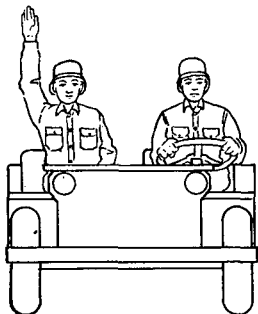

HALT

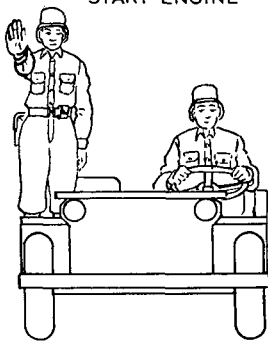

READY TO START

FIGURE 6.—Driver's arm signals.

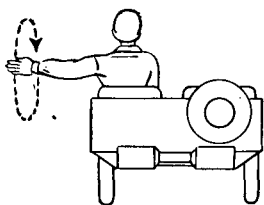

CLOSE UP

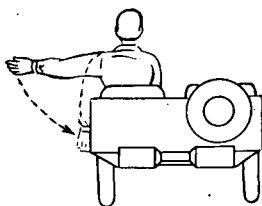

OPEN UP

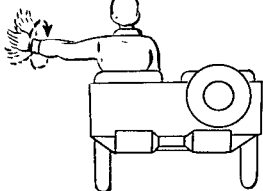

PASS AND KEEP GOING

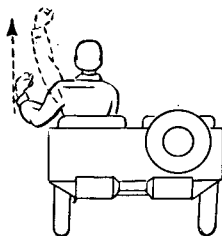

INCREASE SPEED

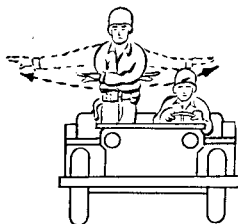

STOP ENGINE

DRIVER TURN AROUND
SIMULTANEOUSLY

FIGURE 7.—Driver's arm signals.

**MOVE IN REVERSE****CHANGE DIRECTION****CLOSE UP OR CAUTION****FIGURE 8.—Guide signals.**

CHAPTER 2

TRAINING FOR PLACING WEAPONS IN ACTION

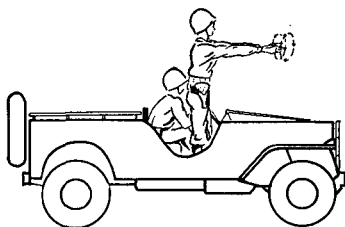
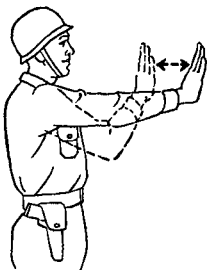
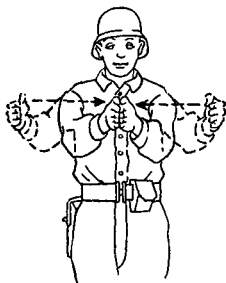
| | Paragraphs |
|-------------------------------------|------------|
| SECTION I. Elementary training..... | 7-11 |
| II. Advanced training..... | 12-17 |

SECTION I

ELEMENTARY TRAINING

■ 7. **PURPOSE AND SCOPE.**—Crew training develops the crew so that it may function as a team with precision and speed in placing its weapon in action, taking it out of action, serving it during firing, and in continuing it in action at reduced strength. This training is divided into two phases, elementary and advanced.

■ 8. **GENERAL.**—*a.* In general, drill is controlled by the visual signals described in paragraph 6.

b. Team play is emphasized. To obtain teamwork each member of the crew must understand thoroughly his duties and their relation to and effect upon duties of the other members of the crew.

c. Movements are executed rapidly. As individual and crew proficiency is attained, speed is developed. During the early stages of instruction, movements are carefully explained and demonstrated and individuals are required to execute the drill slowly and with precision. The tempo of the drill is gradually increased until movements can be executed rapidly without confusion.

d. Continuation of the gun in action with the crew at reduced strength is assured by rotating members, including the driver, during drill.

■ 9. **DEFINITIONS AND TERMS.**—*a. March order.*—The destroyer crew is in march order when the gun is covered, tools and equipment properly secured, and members of the crew

seated in their usual travel positions. A crew will not move in march order if there is any possibility of immediate action.

b. Prepared for action.—The destroyer or antiaircraft gun is prepared for action when the gun covers are removed, the crew at or near firing positions, and the gun in order for immediate loading and firing.

c. Fire orders.—Fire orders are as follows:

(1) *Initial fire orders.*—(a) *Type of ammunition.*—Given only when ammunition other than APC is to be used.

(b) *Direction.*—Whenever time permits, immediately upon selection of a firing position, a reference point near the center of the sector will be designated by each destroyer commander. Direction may be given in any of the following forms:

1. When *inside* the destroyer: TRAVERSE RIGHT (LEFT) STEADY-Y-Y-Y, ON.

2. When *outside* the destroyer:

(a) *General direction.*—RIGHT FRONT, LEFT FRONT, etc.

(b) *Clock system.*—TWO O'CLOCK, TEN O'CLOCK, etc. For the purpose of clarity, a combination of direction and clock system may be used, such as RIGHT FRONT, TWO O'CLOCK.

(c) *Reference point and mils.*—REFERENCE POINT, RIGHT 200, REFERENCE POINT CHURCH STEEPLE, LEFT 90, etc. The azimuth indicator may be used with this method by laying the gun on the reference point initially with zero set on the scale.

(d) *Reference point and fingers.*—REFERENCE POINT, RIGHT THREE FINGERS.

(e) *Reference point and distance.*—REFERENCE POINT, LEFT 100 YARDS. (For short ranges only.)

(c) *Target description.*—LEADING TANK, REAR TANK, TANK WITH FLAG, etc.

(d) *Range*.—"400," "600," "1200." Range is always given to the nearest 100 yards. 400 is announced as "Four hundred," 1000 as "One thousand," 1200 as "One two hundred," etc.

(e) *Special method of control (if any)*.—AT MY COMMAND. This indicates that the gunner is to lay for range and begin tracking, using an estimated lead until the destroyer commander is ready for the gunner to fire, at which time he will announce a lead.

(f) *Leads*.—ONE LEAD, TWO LEADS, etc. Announcement of the lead is the command to fire.

(g) *Examples of initial fire orders*.—

1. HE, TRAVERSE RIGHT, STEADY-Y-Y-Y, ON, LEADING TANK, 600, AT MY COMMAND, 2 LEADS.
2. LEFT FRONT, TEN O'CLOCK, LAST TANK, 500, ONE LEAD.

(h) Preceding the above commands, the destroyer commander may call "Gunner," in order to alert the gunner.

(i) The gunner will *not* repeat the fire order, but will call "Check" after the range has been given and he has identified the target, laid for range, and is ready for the balance of the order. If any element of the order is not understood, the gunner will ask for it. For example, if he fails to hear the range, he will ask "Range?"

(2) *Subsequent fire orders*.—(a) Range changes will be announced by the destroyer commander as UP 300 or DOWN 100, etc.

(b) Corrections in leads will be announced as one more, two less, etc.

(c) The destroyer commander *may* sense the round for range before giving the correction. For example: SHORT, UP 400, ONE MORE, or OVER, DOWN 200, TWO MORE.

(d) An entirely new range and lead may be ordered at any time. When a hit is obtained, additional rounds will be fired to effect destruction of the target.

(e) The command REPEAT may be given when the destroyer commander wishes to fire another round with the same range and lead as the preceding round.

■ 10. RANGE ESTIMATION.—*a.* Estimation of ranges is facilitated by the use of mil scales in sights and field glasses. Although generally the smallest graduation is 5 mils, more accurate readings may be made by using for a scale the length of a subdivision line; these lines subtend approximately 2 mils in many instruments. Conversion tables for rapidly converting mil readings to yards should be pasted on field glass cases and on gun shields near the sights. For example, tables to the nearest 50 yards for use against German MK IV tanks are:

| Mils..... | 1 | 2 | 3 | 4 | 5 | 6 | 7 | 8 | 9 | 10 |
|---------------------|------|------|------|------|------|------|-----|-----|-----|-----|
| Ranges in yards: | | | | | | | | | | |
| End view | 2400 | 1200 | 800 | 600 | 500 | | | | | |
| Side view | | 2850 | 1900 | 1400 | 1150 | 950 | 800 | 700 | 650 | 550 |
| Diagonal view.. | | 3100 | 2050 | 1550 | 1250 | 1050 | 900 | 750 | 700 | 600 |

The above tables also approximately apply to the German Mark III tank. The tables were prepared from authoritative data at the time of publishing. *They should be verified or corrected prior to combat.*

b. (1) The 360° system of angular measure is inadequate for gunnery. For example, if you fire at a tank 1,000 yards away and traverse the gun tube 1° to the right (or left), the next shot will land about 18 yards from the first. Breaking the degree up into tenths would result in confusion. Using the standard minutes and seconds system would be even worse. So in gunnery a "mil" system is used.

(2) A mil (abbreviated *m*) is an angle subtended by an arc of 1 yard at a range of 1,000 yards. It is approximately 1/6400th of a circle, 360°. Consequently there are 3,200 mils in a half circle, 1,600 mils in a right angle, 800 mils in a 45° angle, etc.

(3) Going back to the tank at the 1,000-yard range mentioned above, if you traverse the gun enough to fire the second shot 1 yard to the right (or left), you move the gun 1 mil. The relationship between the 1 mil, the 1 yard, and the 1,000 yards is called the mil relation.

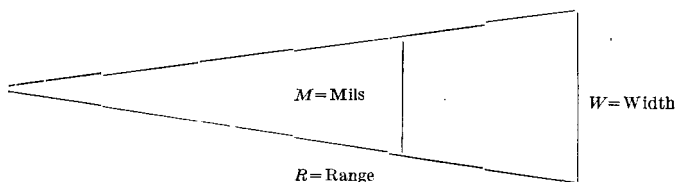

Let W represent the width in yards, R the range in thousands of yards, and M the number of mils in the angle. You can write the formula W/RM (W over RM —remember by the word *WORM*). This formula is practically correct but is good only for angles of 400 mils or less. With this formula you can find one unknown element when you know the other two, by striking out the one you want to know.

(4) *Examples.*—(a) How many mils is it necessary to traverse a gun to change the shell burst 18 yards at a range of 2,000 yards? Striking out the M leaves W over R , 18 over 2 or 9 mils.

(b) At a range of 1,500 yards, how far will a 10-mil change in deflection move a shell burst? Striking out W leaves MR , 10 times 1.5 or 15 yards.

(c) How far away is a 60-foot tree that measures 10 mils on the vertical mil scale? Changing 60 feet to yards and substituting gives 20 over 10=2,000 yards.

■ 11. OPERATION OF INTERPHONE AND RADIO.—a. In vehicles equipped with interphone and radio, interphone communication is provided for all crew members. In addition, radio communication is provided for the commander and one other crew member referred to in this paragraph as the assistant operator. The interphone should be used whenever the tank destroyer is operated. As standing operating procedure immediately after mounting, headsets and microphones are put on and tested according to the following procedure:

(1) Each crew member plugs in his headset and microphone cords.

(2) The destroyer commander and assistant operator turn their radio-interphone switch in INT, the other crew mem-

bers to RADIO. The commander orders CHECK INTERPHONE. Each member of the crew in the following order: gunner, assistant gunner, assistant driver, and driver, reports "Ready" to the destroyer commander. During this procedure, each crew member adjusts the volume control on his interphone control box to the desired level. Care must be taken that the microphone switch does not remain in a locked position.

(3) The RADIO-INT switches on all control boxes, except the destroyer commander's and the assistant operator's, *must be set on RADIO. This is the normal position for interphone operation.* Except in an emergency, *no one but these two members* may operate the RADIO-INT switch on his control box. In an emergency, the driver may signal the operator by throwing his control box switch to INT and simultaneously operating his microphone switch. *He should immediately return his control box switch to RADIO.* This signal consists of a loud tone in the destroyer commander's or operator's headset which interferes with his reception of the radio. Upon receipt of this signal the commander, or assistant operator, operates his control box switch to INT at the earliest opportunity and establishes interphone communication with the crew. Whenever the commander must establish interphone communication with the crew, the assistant operator throws his switch to RADIO and tends the radio.

(4) The commander or assistant operator reports into the radio net at the designated time. When the net is opened, one qualified crew member must tend the radio at all times.

b. It is the duty of each man to check his personal interphone equipment upon mounting the destroyer; he should see that it is properly maintained, and report any difficulties to the destroyer commander.

c. Definite vehicle control commands and terminology reduce conversation to a minimum. The use of general conversation minimizes the value of the interphone, and is conducive to frequent misunderstandings and disorder and breaks down crew discipline. The following interphone language illustrates the simplicity and brevity which must be used.

(1) *Terms.*

| | |
|----------------------------|---|
| Destroyer commander..... | Sergeant. |
| Driver..... | Driver. |
| Gunner..... | Gunner. |
| Assistant gunner..... | Loader. |
| Any armored vehicle..... | Tank, half-track, armored car, de- stroyer. |
| Any unarmored vehicle..... | Truck, car. |
| Any antitank gun..... | Antitank. |
| Infantry..... | Infantry. |
| Machine gun..... | Machine gun. |
| Airplane..... | Plane. |

(2) *Commands for movement of destroyer.*

| | |
|---------------------------------|---|
| To move forward..... | DRIVER MOVE OUT. |
| To halt..... | DRIVER STOP. |
| To reverse..... | DRIVER REVERSE. |
| To decrease speed..... | DRIVER SLOW DOWN. |
| To increase speed..... | DRIVE FASTER. |
| To change direction..... | DRIVER RIGHT (LEFT). |
| To turn right (left) 180°..... | DRIVER COUNTER- MARCH RIGHT (LEFT). |
| To follow in column..... | DRIVER FOLLOW THAT VEHICLE (DRIVER FOL- LOW THAT HALF- TRACK A2). |
| To follow on road or trail..... | DRIVER STAY ON ROAD (TRAIL). |
| To start engine..... | DRIVER CRANK UP. |

To stop engine----- DRIVER CUT EN-
GINE.
To proceed in a specific range. DRIVER THIRD
RANGE.
To proceed at same speed----- DRIVER STEADY.

(3) *Commands for control of turret.*

To traverse turret----- GUNNER TRAVERSE
LEFT (RIGHT)
(REAR).
To stop turret traverse----- GUNNER STEADY-
Y-Y-Y, ON.

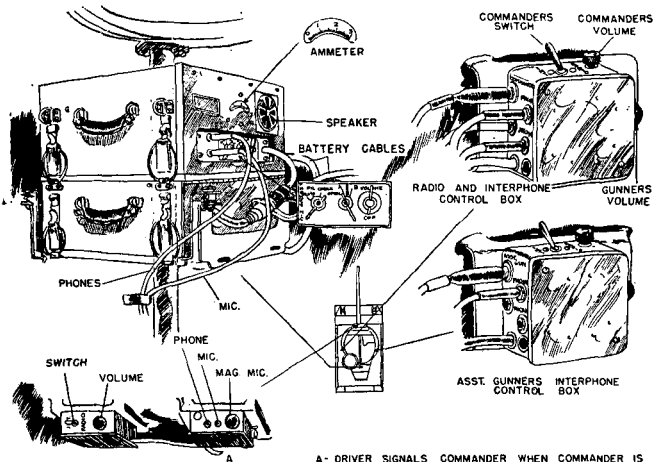

A - DRIVER SIGNALS COMMANDER WHEN COMMANDER IS OPERATING RADIO. DRIVER CAN SIGNAL HIM BY THROWING SWITCH TO INT. AND PRESSING MICROPHONE SWITCH. THIS PUTS TONE IN COMMANDERS HEADSET.

INTERPHONE CONTROL BOXES
HABITUALLY SWITCHED TO
RADIO POSITION.

FIGURE 9.—Details of radio and interphone control boxes.

1 (4) *Miscellaneous.*

| | |
|------------------------------------|------------------------------------|
| To dismount..... | DISMOUNT. |
| To dismount and fight on foot..... | FIGHT ON FOOT. |
| To dismount and abandon vehicle. | ABANDON VEHICLE. |
| To indicate action..... | ACTION RIGHT (LEFT) (FRONT). |
| To go out of action..... | OUT OF ACTION. |
| To close vehicle hatches..... | CLOSE HATCHES. |
| To abandon and destroy equipment. | ABANDON AND DESTROY GUN (VEHICLE). |
| To give fire alarm..... | ENGINE FIRE (HULL FIRE). |

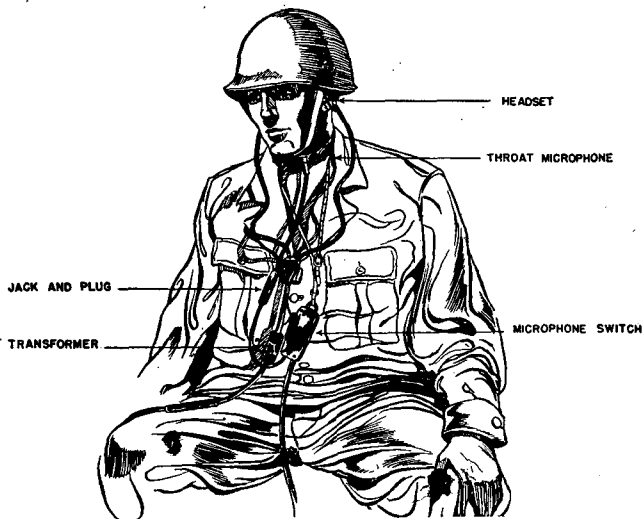

FIGURE 10.—Details of personal equipment for interphone and radio.

SECTION II

ADVANCED TRAINING

■ 12. GENERAL.—*a.* After crews have become proficient in the service of the piece, they are trained in reconnaissance, selection, and occupation of positions. *Practice under simulated combat conditions will be stressed.* (See FM 18-5.)

b. At all times instructors should be alert to stress the importance of terrain to prevent the destroyer from presenting an easily hit target. Instructors should emphasize the fact that the *proper* use of terrain will enable the crew to bring destructive fire on the enemy without unnecessary exposure.

■ 13. RECONNAISSANCE FOR POSITION.—*a.* Crews are trained to reconnoiter for position.

b. During deliberate occupation of position, a crew leader should park his vehicle under cover and conduct a dismounted reconnaissance. Initially, training in reconnaissance for position should be conducted on foot.

c. After the members of the crew have become proficient in reconnaissance, they should be trained in making rapid, accurate decisions on the use of the terrain within the assigned area.

■ 14. DESTROYER FIRING POSITIONS.—*a.* Positions seldom will be found that will provide all desirable characteristics. A *good field of fire* and provision for *mutual support* are two requirements that must be met in all positions. The crew leader will make maximum use of other desirable features, balancing the advantages and disadvantages of possible positions.

b. Uneven ground.—If the ground is sloping, the destroyer should be sited so as to cause the minimum amount of cant to be applied to the gun.

c. Field of fire.—The position must have a field of fire that permits the crew to accomplish its mission. It is desirable that the field extends as far as the gun's maximum effective range with a minimum of dead space.

d. Mutual support.—The crew must be able to support adjacent and nearby crews. Failure to provide mutual support will permit the enemy to bring the fire of several tanks against a single destroyer.

e. Cover.—A deflated position or a dug-in position lessens the size of the target presented to the enemy and protects the crew and ammunition. Self-propelled guns frequently are dug in when operating on flat, open terrain; the emplacement is so constructed that the vehicle may displace quickly under its own power.

f. Concealment.—The gun crew will utilize every available means of concealment consistent with the accomplishment of its mission. (See FM 21-45 and 5-20.)

g. Flanking fire.—Wherever possible, guns will be sited to bring flanking fire upon hostile tanks. A tank crossing the line of fire is more difficult to hit than one approaching frontally. However, tanks are much less vulnerable in front than on the side. Furthermore, many tanks have more fire power to the front than to the side, and crews are prone to observe more to their front than to their flanks.

h. Covered routes to alternate and supplementary positions.—Whenever time permits, alternate and supplementary positions are selected. The routes covered should be noted carefully so that the destroyer can be moved through smoke.

i. Absence of covered routes for approaching tanks.—Positions to which tanks can approach under cover are avoided.

j. Routes protected by natural or artificial obstacles.—When natural or artificial obstacles stop, delay, or canalize the approach of tanks, the mission of destroying tanks is more easily accomplished.

k. Landmarks.—Whenever possible, avoid positions near prominent landmarks that may serve as registration or identification points for artillery or combat aviation, for example, crossroads, road junctions, stream junctions, railroad crossings, bridges, points of woods, lone or small groups of buildings.

■ 15. ANTI-AIRCRAFT FIRING POSITIONS.—*a.* The ideal position is one which provides a good all-round field of fire against attacking aircraft. In addition to the characteristics men-

tioned in paragraph 14, caliber .50 antiaircraft machine guns should be within 200 yards of the destroyers they are covering; larger caliber antiaircraft guns, if assigned, within 400 yards.

b. Usually the necessity for a field of fire against aircraft takes precedence over all other considerations. However, when hostile aircraft are not active, it may be desirable to site the guns primarily for fire against tanks and other armored vehicles. When hostile aircraft are active intermittently, routes are selected for movement to positions suitable for fire against ground targets.

■ 16. OCCUPATION AND ORGANIZATION OF POSITIONS.—Training in the occupation and organization of positions starts with instruction and practice in deliberate methods, followed by practice in hasty entry into position.

a. *Deliberate occupation and organization of position.*—

(1) When the site is selected, the gun is moved into position and inspection is made *by aiming* to determine whether the gun can cover the prescribed field of fire. In case there is not good cover or concealment at the firing position, the gun is moved to a nearby cover position to await the enemy's approach. One or more observers are posted.

(2) The field of fire is cleared of small obstructions; a position that is handicapped by numerous obstructions to gunfire will be avoided. The gun is camouflaged. Prone shelters are dug for personnel not protected by armor, though the best protection against hostile tank attack is continuous antitank fire.

(3) Measures are taken to minimize the effects of muzzle blast. Vegetation near the muzzle should not be disturbed. Green brush piled under the muzzle, wet cloth on the ground under the muzzle, and soaking the ground with old crank-case oil aid in keeping down the dust. When the ground is covered with snow and the temperature is below freezing, soaking the snow with water will prevent it from being carried away by the blast.

(4) If an emplacement is to be used, precautions are taken to have the gun ready for firing while the construction is in progress.

(5) Alternate and supplementary firing positions are selected.

(6) All-round observation is maintained. Reliefs of observers are established.

b. Hasty occupation and organization of position.—Crews occupying a position hastily organize the position as completely as time permits.

■ 17. GUN COMMANDER'S AND GUNNER'S CATECHISMS.—*a. Gun commander's catechism* (to be asked of himself before he is satisfied with a firing position).—(1) What is my mission?

(2) Have I studied the terrain with my field glasses for all possible tank approaches?

(3) Have I estimated ranges and prepared by range card? Is my range card up-to-date?

(4) Have I checked the boresighting of the gun?

(5) Have I dug trenches for trail shifts?

(6) Have I cleared my field of fire?

(7) Have I checked my gun position for maximum depression? Does this leave dead space that I will have to make short shifts to cover?

(8) Have I reduced gun cant and facilitated traversing by placing my vehicle on level ground?

(9) Have I fired a check round for range? (Time and secrecy permitting.)

(10) Have I checked my ammunition for availability, type to be used, serviceability, and resupply?

(11) Have I made a plan of action in the event of an infantry attack?

(12) Where are the other guns in my section? Platoon? Company?

(13) Have I determined routes that I may have to use in future action?

(14) Have I selected alternate and supplementary positions and prepared range cards for them?

(15) Have I informed the crew of the situation?

(16) Keeping in mind my mission, have I taken advantage of natural camouflage, cover, and concealment?

(17) Have I made plans to counter an air attack?

(18) Should I dig prone shelters?

(19) Do my tracks give me away?

(20) Is artificial camouflage necessary to hide better my gun and crew?

(21) Will my night lighting devices function?

(22) What can I do to reduce dust raised by muzzle blast?

(23) What is my situation as to rations, water, and fuel?

b. *Gunner's catechism* (to be asked of himself before he is satisfied his gun is ready).—(1) Have I boresighted my gun?

(2) Is my sight clean and seated property in its mount?

(3) Is the vehicle parked so the gun can be traversed easily?

(4) Have I cleaned the working parts of my gun?

(5) Is my interphone system working?

(6) Will the firing mechanism work both manually and electrically?

(7) Are the elevating and traversing mechanisms in working order?

(8) Does the gun have the proper amount of recoil oil?

(9) Do I know what range change to make if I shift from AP to HE?

CHAPTER 3

3-INCH GUN MOTOR CARRIAGE M10 AND M10A1

| | Paragraphs |
|---|------------|
| SECTION I. Mechanical training | 18-20 |
| II. Training for placing in action..... | 21-33 |

SECTION I

MECHANICAL TRAINING

■ 18. GENERAL.—The M10 (M10A1) gun motor carriage is a 3-inch (AA) gun, M7, turret-mounted on a medium tank chassis M4, modified. (See par. 19c.) The gun has a 360° traverse, elevation of approximately minus 10° to plus 30°, and is designed for one-man (gunner) control for aiming, elevating, traversing, and firing. Loading and handling of ammunition are done by the assistant gunner (loader). Vehicle is full-track, bogie suspension type, powered by two Diesel engines or Ford tank engines through the medium tank power transmission system. Gross weight of the vehicle with a five-man crew and equipment is approximately 62,500 pounds (31¼ tons).

■ 19. DESCRIPTION.—*a. Gun.*—See TM 9-752, 9-752A, 9-731G, and 9-323. The gun is the 3-inch gun M7. The name of the manufacturer, year of manufacture, serial number, and weight, including the breech mechanism, are stamped on the breech ring.

(1) *Breech mechanism.*—The breech mechanism is of the verticle sliding type, having a rectangular breechblock, operated either semiautomatically or manually. In semiauto-matic operation, the breechblock is opened as the gun returns to battery, by means of a cam mounted on the cradle. The breechblock may also be opened manually by means of the breech operating handle. The breechblock closes automatically as a round of ammunition is loaded into the breech chamber and the rim of the case trips the extractors.

(2) *Firing mechanism.*—To fire the piece, the firing button situated on the elevating handwheel is pressed, actuating the firing pin solenoid through an electric firing system controlled by a master switch in rear of the driver's compartment. The piece may also be fired manually by unlocking the firing bar lock and operating the firing bar by hand. The gun may be fired either manually or electrically from either side of the gun.

b. *Mount.*—The mount (M5) is of the tank turret mount type, with gun trunnions located at the center of gravity of the gun.

(1) *Recoil mechanism.*—The recoil mechanism controls the force created by firing and checks movement of the recoiling mass in a gradual manner. The gun recoils and counter-recoils in a cradle and is controlled by a hydrospring type, constant length recoil mechanism.

(2) *Elevating and traversing mechanism.*—(a) *To elevate or depress.*—Elevation or depression is accomplished by handwheels located on either side of the gun. The solenoid firing button is located on the left handwheel. *To elevate*, the left handwheel is rotated *clockwise*.

(b) *To traverse.*—360° traverse of the gun is accomplished by a large traversing handwheel, located on the side of the turret to the left of the gun which rotates a pinion in mesh with the turret ring gear and causes the turret to rotate. *To traverse right*, the traversing handwheel is rotated *clockwise*.

c. *Vehicle.*—The vehicle is a medium tank chassis M4, modified in the upper hull to carry an open-top turret, mounting the gun. Hull modifications include all-round sloping surfaces to aid in deflection of hostile fire and to provide additional stowage space. Armament includes a caliber .50 Browning machine gun M2, HB mounted in the rear of the turret for antiaircraft use. Stowage spaces for tools and equipment are provided underneath the floor. Six ready-rack brackets are located inside the turret. The balance of the ammunition is carried in the four hull sponsons, each containing 12 rounds.

■ 20. CARE AND MAINTENANCE OF MATÉRIEL.—*a.* Complete instructions for maintenance operations, including disassembly and malfunctions, may be found in TM 9-752, 9-752A, 9-731G, and 9-323.

b. Inspection and adjustment.—The following instructions should be scrupulously observed:

(1) *Gun.*—(*a*) Examine appearance, operation, and lubrication of all parts of the firing mechanism, breech mechanism, breech recess, and tube. Examine all joints, bolts and springs for proper adjustment and condition.

(*b*) Disassemble breech mechanism and examine all parts for cleanliness, mechanical condition, and action.

(2) *Mount.*—(*a*) Examine the appearance, operation, and lubrication of all parts of the elevating and traversing mechanisms. Inspect recoil system for leaks and oil level.

(*b*) Examine all oil plugs and check for possible leaks in recoil system.

(*c*) Note freedom of action of elevating and traversing mechanism and extent of undue backlash.

(3) *Sighting equipment.*—(*a*) Inspect appearance, operation, and condition of all parts of the sighting equipment.

(*b*) Check proper assembly of sight mount and tightness of screws and studs. Inspect alignment and lubrication of sight mount.

c. Cleaning and lubricating.—Systematic cleaning and lubricating at regular intervals is the best insurance against an unexpected break-down at a critical moment when maximum performance is absolutely necessary. Emphasis must be placed on the proper cleaning, drying, and lubrication of the slides, elevating and traversing mechanisms, trunnions, sighting mechanism, and bearing surfaces.

SECTION II

TRAINING FOR PLACING IN ACTION

■ 21. SCOPE.—This section covers training in placing the destroyer in action.

■ 22. COMPOSITION.—A crew consists of a commander, gunner, assistant gunner (loader), assistant driver, and driver.

■ 23. To FORM CREW.—Destroyer commander places himself three paces to front (or rear) of right track of vehicle, facing to front, and commands: IN FRONT (REAR), FALL IN. The others form at double time in line at close intervals on the commander's left in the following order, right to left: destroyer commander, gunner, assistant gunner (loader), assistant driver, and driver.

■ 24. To CALL OFF.—Command: CALL OFF. The gunner calls off, "One"; assistant gunner (loader), "Two"; assistant driver, "Three," and driver, "Four."

■ 25. To POST CREW.*—*a.* Command: POSTS. Members of the crew take posts at a run as follows: destroyer commander in turret to right of tube and forward from the breech, gun-

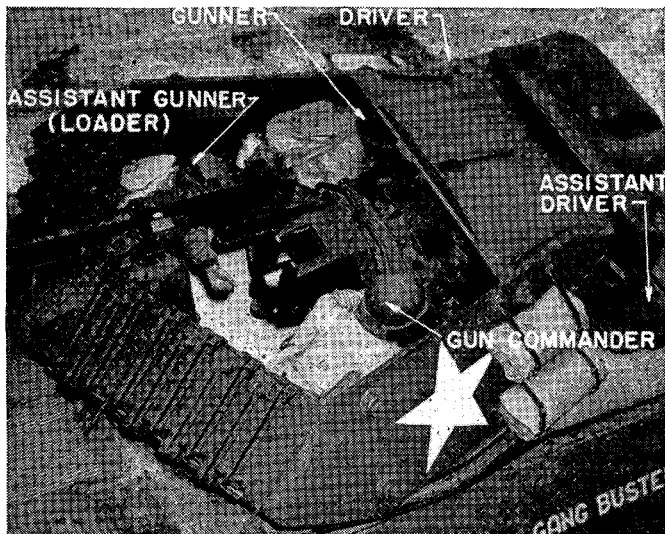

FIGURE 11.—Posts of 3-inch (M10) tank destroyer crew when preparing for action.

* To open hatches and to dismount the crew are explained in paragraphs 40 and 41, respectively.

ner in turret to left of tube and forward from the breech, assistant gunner (loader) in turret behind gunner to left rear of tube, assistant driver in right front seat, and driver in left front seat.

NOTE.—Directions mentioned for positions within turret refer to the *gun* and not the vehicle, unless otherwise specifically indicated.

b. At the command, *POSTS*, the driver and assistant driver mount over the left and right front of the destroyer, respectively, each entering his compartment through the hatch. The gunner and assistant gunner follow, closing right and left hatch doors, respectively, and proceed to their own positions in the turret.

The destroyer commander mounts over right front of the destroyer, taking his position after supervising mounting of the crew.

■ **26. PREPARE FOR ACTION.**—Command: **PREPARE FOR ACTION.**

a. *Duties* (1) *Destroyer commander.*—(a) Directs gun crew to traverse gun clockwise to position of readiness.

(b) Directs vehicle under cover in the general area assigned.

(c) Makes a personal reconnaissance of area or the best position to occupy and best route into it.

(d) Guides vehicle into the selected position.

(e) Directs and supervises the gun crew in preparation for action, including preparation of range card.

(f) Removes muzzle cover.

(g) Unlocks travel lock.

(h) Removes cover from cal. .50 machine gun.

(i) Causes squad members to don interphone sets.

(j) Helps check recoil mechanism (recoil oil level should be checked at least once a day).

(k) Inspects panoramic sight (if so equipped) and mounts and installs sight when indirect fire is ordered.

(l) Checks boresight and adjustment of sight and mount.

(m) Inspects matériel.

(n) Acknowledges report from assistant driver.

(o) Reports, "Destroyer correct. ——— rounds of ammunition, ——— tanks of fuel" to section leader.

(2) *Gunner.*—(a) Unlocks the piece travel lock and left turret lock.

(b) Traverses gun clockwise to position of readiness—right front—as close to "front position" as is possible with driver's hatch open; this will put tube directly over assistant driver's hatch and well within the limits of the width of the vehicle.

(c) Locks travel lock.

(d) Locks left turret lock:

(e) Opens turret sight port.

(f) Checks recoil mechanism (recoil) oil level (should be checked at least once a day).

(g) Inspects telescope sight and mount and installs telescope.

(h) Installs sight filter, if necessary.

(i) Checks sight mount indices.

(j) Inspects and tests firing mechanism, manually and electrically.

(k) Reports to assistant gunner, "Firing mechanism correct."

(l) Checks elevating mechanism; checks maximum depression to various masks in field of fire.

(m) Checks traversing mechanism and traverses piece to the front.

(n) Boresights.

(o) Reports to assistant driver, "Gun correct. ——— rounds at hand."

(3) *Assistant gunner (loader).*—(a) Removes breech cover.

(b) Unlocks right turret lock.

(c) Locks right turret lock (after gun is in ready position).

(d) Checks bore and reports to gunner, "Bore correct."

(e) Cocks gun.

(f) Connects solenoid jack.

(g) Connects interphone jacks for gunner and commander.

(h) Checks battery switches to make sure they are ON.

(i) Recocks gun.

(j) Checks ammunition in sponsons.

(k) Reports ammunition to gunner, "—— rounds on hand."

(l) Opens breech fully and relatches handle.

(m) Reports "Loader ready," and stands by to load on fire order.

(4) *Assistant driver*.—(a) Closes hatch if open; inserts and adjusts periscope.

(b) Inspects radio.

(c) Inspects interphone controls.

(d) Receives gunner's report.

(e) Reports gunner's and driver's report to commander, "Gun correct. —— round on hand. —— tanks of fuel."

(f) Listens on radio net for orders.

(5) *Driver*.—(a) Closes hatch if open.

(b) Opens hatch after gun has been traversed to position of readiness.

(c) Connects own interphone.

(d) Closes hatch; inserts and adjusts periscopes.

(e) Inspects engine for operation. Reads gauges.

(f) Throttles engine(s) to turn at 800 rpm.

(g) Moves vehicle as directed by gun commander.

(h) Gives assistant driver fuel report, using interphone, "—— tanks of fuel."

b. *Posts, halted*.—Having prepared the destroyer for action, members of the squad take posts as follows:

(1) *Destroyer commander*.—In a position on or near his seat.

(2) *Gunner*.—Immediately to the left of the breech.

(3) *Assistant gunner (loader)*.—At rear of breech.

(4) *Assistant driver*.—On his seat.

(5) *Driver*.—On his seat.

c. *Posts, marching*.—Same.

■ 27. DUTIES OF MEMBERS OF GUN CREW DURING MARCHES.—When prepared for action during the march, members observe definite sectors for both air and ground attack:

a. *Destroyer commander*.—General observation of surrounding terrain and sky, picking likely positions and choosing routes of movement.

b. *Gunner*.—To rear, right rear, and right flank of vehicle, both ground and air.

c. *Assistant gunner (loader)*.—To rear, left rear, and left flank of vehicle, both ground and air.

d. *Assistant driver*.—To right front, front, and left front of vehicle, both ground and air.

e. *Driver*.—Road ahead, and for short distances to right and left of the road, keeping sharp lookout for any evidence of mines, barricades, etc. He continually selects points at which the vehicle could leave the road.

■ 28. **STAND BY**.—Command: **STAND BY**. Members of crew observe sectors as in paragraph 27, and remain alert. The driver stops the vehicle in the best concealment or cover available, keeps engine(s) at proper idling speed, and makes a quick check of the condition of the vehicle.

■ 29. **DUTIES IN FIRING**.—Duties in firing are:

a. *Destroyer commander*.—Is responsible for proper performance of duties, execution of commands, and safety precautions, and fires antiaircraft gun. Assumes independent command in the absence of higher authority. When in the turret, fires the piece at command of gunner by manual device when solenoid fails.

b. *Gunner*.—Lays piece for direct firing and fires piece.

c. *Assistant gunner (loader)*.—Secures ammunition and loads piece. When destroyer commander is not in turret, fires piece at command of gunner by manual device when solenoid fails.

d. *Assistant driver*.—Supervises communication as directed by commander.

e. *Driver*.—Observes to front, keeps engine(s) running at 800 rpm, and moves destroyer as directed.

■ 30. **DETAILED DUTIES IN FIRING (DIRECT LAYING)**.*—a. *Destroyer commander*.—(1) Selects primary, alternate, and supplementary positions.

*See paragraphs 48 to 55, inclusive, to suspend firing, to cease firing, duties after firing, detailed description of certain duties (in case of fire), dismantled action, and inspections.

- (2) Responsible for fire discipline.
- (3) Selects target and proper ammunition.
- (4) Issues fire order.
- (5) Fires gun manually if necessary.
- (6) Observes fire.
- (7) Adjusts fire by subsequent fire orders.
- (8) Causes destroyer to be moved to alternate or supplementary position when necessary.
- (9) Shifts fire to new target when original target has been destroyed.

(10) Fires antiaircraft machine gun unless another crew member is designated. (See par. 58.)

(11) Insures that casualties are replaced when possible.

b. Gunner.—(1) Identifies target and lays gun on target with proper range; announces "check" as prescribed in paragraph 9c(1)(i).

(2) Lays gun on target with proper lead.

(3) Fires the gun electrically.

(4) In manual firing, causes gun to be fired by commanding, "Ready, fire."

(5) In shifts over 800 mils, directs the driver through interphone as to proper shifting of vehicle.

(6) Assumes command if destroyer commander is a casualty.

c. Assistant gunner (loader).—(1) Loads piece.

(2) Calls, "Clear," and taps gunner on back when clear of recoil.

(3) Prepares the ammunition and when firing HE shell, sets fuze.

(4) Reports ammunition status.

(5) Clears empty shell cases from floor during lulls in firing.

(6) When destroyer commander is not in turret, fires the piece at command of gunner by manual device when solenoid fails.

d. Assistant driver.—(1) Observes to front through periscope.

- (2) Operates radio as directed by commander.
 - (3) Responsible that commander receives all orders from higher headquarters promptly.
 - (4) Takes place of any member who is a casualty.
 - (5) Relieves the driver when he is fatigued.
- e. Driver.*—(1) Observes to left through periscope.
- (2) Keeps engine(s) running at 800 rpm and observes instruments.
 - (3) Takes over assistant driver's duties if he replaces a casualty.
 - (4) Keeps commander informed of fuel supply.

■ 31. DETAILED DUTIES IN FIRING (INDIRECT LAYING).—*a. Destroyer Commander.*—(1) Lays gun as directed by platoon leader.

- (2) Selects or identifies aiming point.
- (3) Follows fire commands as received.
- (4) Informs assistant gunner (loader) what ammunition charge and fuze are required if asked for them.
- (5) Traverses gun under direction of gunner.
- (6) Informs assistant gunner (loader) of required quadrant elevation if asked for it.
- (7) Elevates or depresses gun to center quadrant bubble.
- (8) Measures the elevation.
- (9) Measures the minimum elevation.
- (10) Reports the minimum elevation.
- (11) Reports to platoon leader "No. 1 (two, three, four) ready," or raises hand when piece is ready to be fired.
- (12) Fires gun as directed by platoon leader.

b. Gunner.—(1) Assumes command if destroyer commander is a casualty.

- (2) Moves to panoramic sight and centers sight bubble.
- (3) Identifies aiming point and refers to it.
- (4) Directs commander in traversing piece.
- (5) Sets or changes the deflection and applies the deflection difference.
- (6) Calls, "Ready."
- (7) Measures the deflection and records base deflection when ordered.

c. Assistant gunner (loader).—(1) Prepares gunner's quadrant for use.

(2) Loads gun when given quadrant elevation.

(3) Sets quadrant at required elevation.

(4) Sets quadrant on leveling plates and tells commander when bubble is centered.

(5) Removes quadrant from leveling plates, and when clear of recoil calls, "Clear," and taps commander on back.

(6) Reports ammunition status to commander.

d. Assistant driver.—(1) Operates radio as directed by commander.

(2) Puts out aiming stakes.

(3) Responsible that commander receives all orders from higher headquarters.

e. Driver.—(1) Places destroyer as directed by platoon leader and sets brakes.

(2) Stops engine(s).

(3) Dismounts and camouflages destroyer.

■ 32. TO MOVE TO ALTERNATE OR SUPPLEMENTARY POSITION.—*a.*

Destroyer commander.—(1) Orders gun locked to right front, inboard, or where desired.

(2) Orders gun left loaded or unloaded as desired.

(3) Directs driver to move in desired direction.

b. Gunner.—(1) Traverses gun to position ordered by commander.

(2) Locks piece travel lock and left turret lock.

c. Assistant gunner (loader).—(1) Clears empty shell cases from floor.

(2) Unloads gun if so ordered by commander.

(3) Locks right turret lock.

d. Assistant driver.—(1) Operates radio as directed by commander.

(2) Responsible that commander receives all orders from higher headquarters.

e. Driver.—(1) Prepares to move vehicle on orders from commander.

(2) *On order to move, inquires, "Are turret locks engaged?"*

■ 33. To EXECUTE MARCH ORDER.—Command: MARCH ORDER. Duties are:

a. *Destroyer commander*.—(1) Supervises work of crew.
(2) Inspects gun to see that tube is unloaded and inboard.
(3) Checks that piece is locked in traveling position.
(4) Checks both turret locks.
(5) Reports to next higher commander, "Destroyer march order. _____ rounds. _____ tanks fuel."

(6) Directs driver to move in proper direction.

b. *Gunner*.—(1) Places gun in traveling position and locks piece travel lock.

(2) Locks left turret lock.

(3) Orders assistant gunner (loader) to lock right turret lock.

(4) Closes sight port.

(5) Removes sight filter.

(6) Reports to assistant driver, "March order, _____ rounds on hand."

c. *Assistant gunner (loader)*.—(1) Checks bore to see that it is clear and reports, "Bore correct."

(2) Disconnects solenoid jack.

(3) Locks right turret lock.

(4) Disposes of empty shell cases.

(5) Replaces and secures ammunition in ready racks.

(6) Replaces breech cover.

(7) Reports to gunner, "_____ rounds on hands."

d. *Assistant driver*.—(1) Unlocks hatch.

(2) Removes periscope and places it in container.

(3) Opens hatch.

(4) Reports to commander, "Destroyer march order."

(5) Listens on radio.

(6) On alert to use available small arms.

e. *Driver*.—(1) Unlocks hatch.

(2) Removes periscope and places it in container.

(3) Checks fuel and lubricant gauges.

(4) Reports to assistant driver, "_____ tanks fuel."

(5) Opens hatch.

(6) On order to move, inquires, "Are turret locks engaged?"

(7) Moves out as directed upon receiving, "Turret locks engaged."

Note.—The turret traversing mechanism of 3-inch gun motor carriages M10 and M10A1 acts as an auxiliary turret brake when the turret traversing locks are not engaged. However, the traversing mechanism is not basically strong enough to lock the turret securely when traveling, particularly over rough terrain. If the traversing mechanism breaks with the primary locks not engaged, the gun tube will swing around and strike the heads of the driver and assistant driver, causing serious injuries or loss of life.

To avoid such an accident, do not operate the 3-inch gun motor carriages M10 and M10A1 until *both* turret traversing locks are securely fastened. To insure proper engagement of lock, a visual inspection of engaged teeth should be made if the vehicle is equipped with a screw type lock. On the eccentric type lock, the position of handle is sufficient evidence of engagement.

CHAPTER 4

76-MM GUN MOTOR CARRIAGE T70

| | Paragraphs |
|---|------------|
| SECTION I. General..... | 34 |
| II. Training for placing in action..... | 35-55 |

SECTION I

GENERAL

■ 34. DESCRIPTION.—The tank destroyer T70 is a 76-mm gun, turret mounted, on an armored full track vehicle. The gun has 360° traverse, elevation from approximately minus 10° to plus 20°, and is designed for one-man (gunner) control for aiming, laying, and firing. Loading and handling of ammunition are done by the assistant gunner (loader). The vehicle is powered with a nine-cylinder, air-cooled, 400-horsepower radial gasoline engine and is capable of speeds up to 55 mph with a cruising radius of 150 miles. Details of care and maintenance of gun and vehicle will be found in TM 9-755 and 9-308.

SECTION II

TRAINING FOR PLACING IN ACTION

■ 35. SCOPE.—This section covers training for placing the destroyer in action.

■ 36. COMPOSITION.—A crew consists of a commander, gunner, assistant gunner (loader), assistant driver, and driver.

■ 37. TO FORM CREW.—Command: DISMOUNTED POSTS. The crew forms in one rank. (See fig. 12.) The destroyer commander takes post three paces in front or rear of the right track, facing the front, and commands: IN FRONT (REAR), FALL IN. The gunner, assistant gunner, assistant driver, and driver, in order, take posts on the left of the destroyer commander at close interval.

■ 38. **To CALL OFF.**—Command: **CALL OFF.** The gunner calls off “One”; assistant gunner (loader), “Two”; assistant driver, “Three”; and “driver, “Four.”

■ 39. **To POST CREW.**—*a.* Command: **POSTS.** Members of the squad take posts at a run as follows:

(1) *Destroyer commander.*—In turret, standing on platform within the antiaircraft machine-gun ring.

(2) *Gunner.*—In turret, on gunner’s seat, to left of 76-mm gun.

(3) *Assistant gunner.*—Standing in turret to right of 76-mm gun (when vehicle is in motion he may be seated).

(4) *Assistant driver.*—In assistant driver’s seat (right).

(5) *Driver.*—In driver’s seat (left).

b. At the command posts, the driver and assistant driver mount over the left and right front of the destroyer, respectively, each entering his compartment through the hatch. The gunner and assistant gunner follow the driver and assistant driver, closing left and right hatch doors, respectively, and proceed to their positions in the turret. The destroyer commander mounts over the left side of the destroyer after supervising mounting of the crew.

■ 40. **To OPEN HATCHES.**—Command: **OPEN HATCHES.** The driver and assistant driver pull their periscopes to travel position, open their hatches, and adjust their seats to the highest position.

■ 41. **To DISMOUNT CREW.**—Command: **IN FRONT (REAR), FALL IN.** Headsets and microphones are disconnected and crew members dismount as follows:

a. The destroyer commander emerges from the turret and takes his dismounted post via the left side.

b. The driver and assistant driver dismount through their respective hatches and proceed to their dismounted posts.

c. The gunner and assistant gunner leave the turret and follow the assistant driver and driver to their posts via the front of the right and left sponsons, respectively.

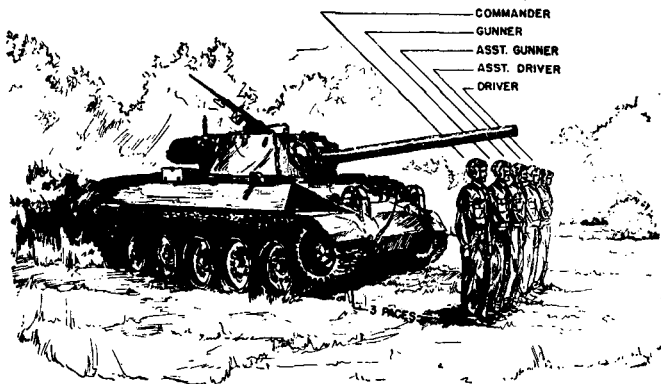

FIGURE 12.—Crew at DISMOUNTED POSTS.

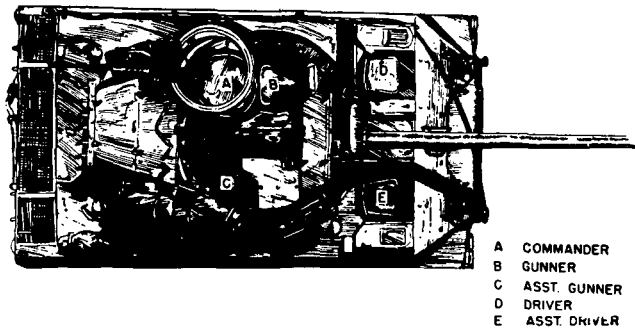

FIGURE 13.—MOUNTED POSTS.

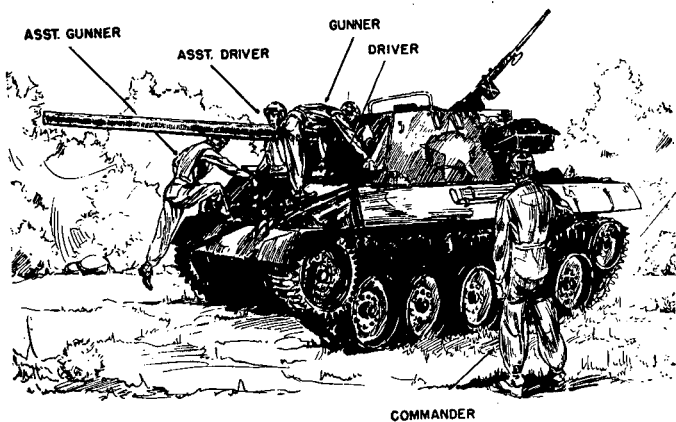

FIGURE 14.—Crew mounting the destroyer.

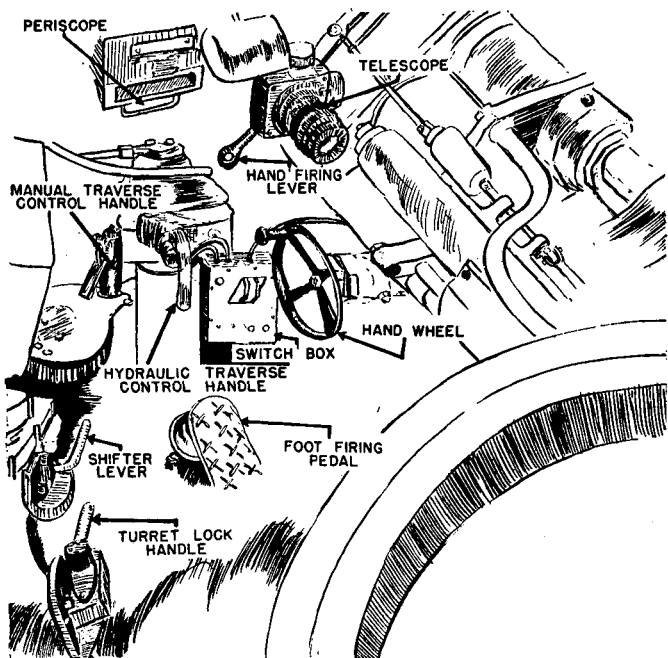

FIGURE 15.—Controls operated by the gunner.

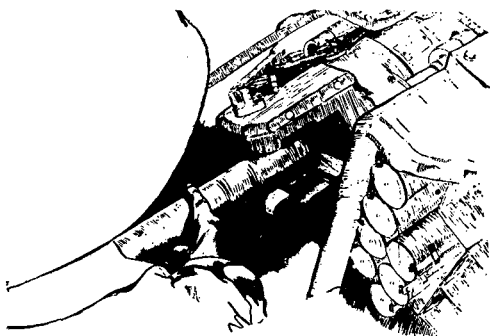
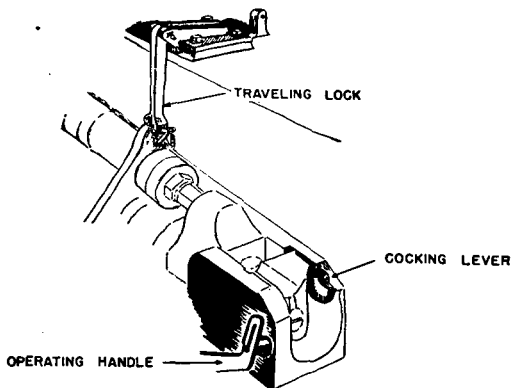

FIGURE 16.—Closing breech when gun is unloaded.



IN REAR OF TURRET

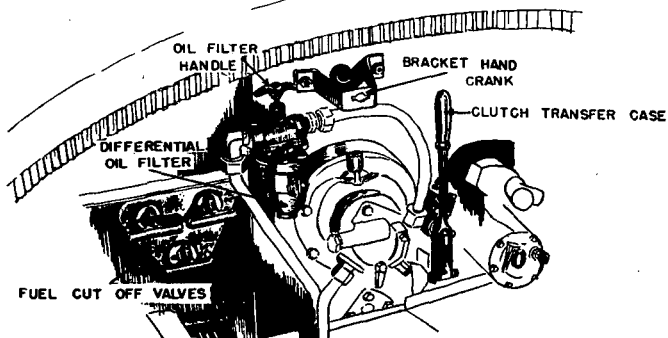

FIGURE 17.—Controls operated by assistant gunner.

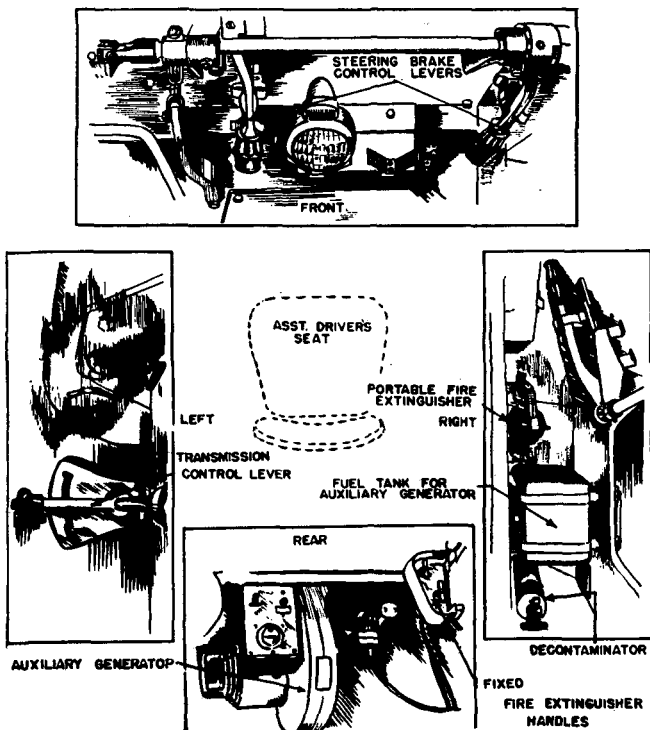

FIGURE 18.—Controls operated by assistant driver.

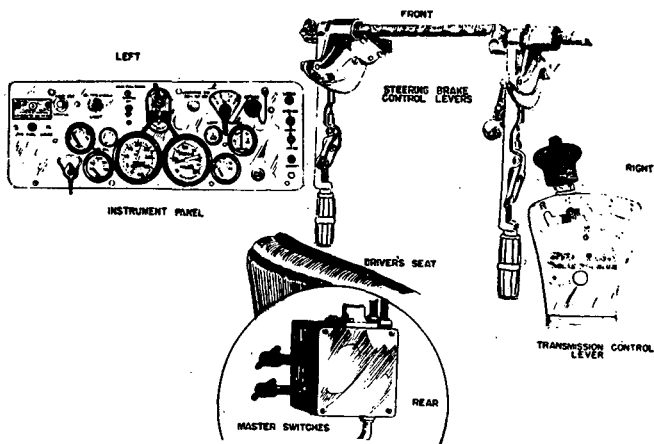

FIGURE 19.—Controls operated by driver.

d. The assistant gunner remains in the destroyer as radio tender when the radio is to be operated.

■ 42. PREPARE FOR ACTION.—Command: PREPARE FOR ACTION. Duties are:

a. *Destroyer commander.*—(1) Directs vehicle under cover in the general area assigned.

(2) Makes a personal reconnaissance of area for the best position to occupy and best route into it.

(3) Guides vehicle into selected position.

(4) Directs and supervises the gun crew in preparation for action, including preparation of range card.

(5) Removes muzzle cover (if dismantled).

(6) Removes cover from caliber .50 machine gun.

(7) Assists in removing breech cover.

(8) Checks interphone and radio connection.

(9) Checks boresight.

(10) Inspects matériel.

(11) Acknowledges report of assistant driver.

(12) Reports or signals, "Destroyer number _____ correct. _____ rounds of ammunition, _____ tanks of fuel."

b. Gunner.—(1) Engages elevating mechanism.

(2) Assists in unlatching gun traveling lock.

(3) Unfastens gun cover and assists in removing it from the breech.

(4) Releases turret traversing lock.

(5) Engages, starts, and checks the operation of the power traversing mechanism.

(6) Checks hand elevating and traversing mechanism, and maximum depression to various masks in field of fire.

(7) Opens sight port.

(8) Boresights.

(9) Inspects periscope and sights, and checks settings of sight adjusting knobs.

(10) Checks periscope for tightness in periscope holder.

(11) Checks recoil mechanism.

(12) Checks manual firing device.

(13) Checks solenoid firing device.

(14) Reports to assistant gunner, "Firing mechanism correct."

(15) Checks interphone connection.

(16) Reports to assistant driver, "Gun correct, _____ rounds on hand."

c. Assistant gunner.—(1) Disconnects gun mount traveling lock.

(2) Removes over-all breech cover.

(3) Opens breechblock and inspects bore; closes breechblock.

(4) Reports to gunner, "Bore correct."

(5) Cocks gun under direction of gunner.

(6) Checks turret ready clips to be sure they are full.

(7) Reports ammunition to gunner, "_____ rounds on hand."

(8) Checks radio connections.

(9) Opens breechblock.

(10) Reports "Loader ready," and stands by to load on fire order.

d. Assistant driver.—(1) (Remove muzzle cover if destroyer commander is mounted.) Adjusts seat to low position.

(2) Closes hatch and adjusts periscope.

- (3) Checks interphone connections.
- (4) Starts auxiliary generator.
- (5) Repeats gunner's and driver's report to destroyer commander. "Gun correct, _____ rounds on hand; _____ tanks of fuel."

e. Driver.—(1) Adjusts seat to low position.

- (2) Closes hatch.
- (3) Adjusts periscope.
- (4) Checks interphone connections.
- (5) Checks battery switches.
- (6) Checks engine operation.
- (7) Moves vehicle as directed by gun commander.
- (8) Reports to assistant driver, "_____ tanks of fuel."

■ 43. DUTIES OF MEMBERS OF DESTROYER CREW DURING MARCHES.—See paragraph 27.

■ 44. STAND BY.—See paragraph 28.

■ 45. DUTIES IN FIRING.—Duties in firing are:

a. Destroyer commander.—Is responsible for proper performance of vehicle and crew, execution of commands, and observance of safety precautions, and fires antiaircraft machine gun. Operates radio and assumes independent command in the absence of higher commander.

b. Gunner.—Lays for direct firing and fires the piece.

c. Assistant gunner (loader).—Secures ammunition and loads. Assists in operation of radio.

d. Assistant driver.—Remains on the alert, observing his sector.

e. Driver.—Observes his sector, keeping engine(s) running at 800 rpm.

■ 46. DETAILED DUTIES IN FIRING (DIRECT LAYING).—*a. Destroyer commander.*—(1) Selects primary, alternate, and supplementary positions.

(2) Issues fire order.

(3) Observes and adjusts fire by subsequent fire orders.

(4) Causes destroyer to be moved to alternate or supplementary position when necessary.

(5) Shifts fire to new targets as necessary.

(6) Fires antiaircraft machine gun.

(7) Insures replacement of casualties when possible.

(8) Exercises general supervision over crew and weapons.

b. Gunner.—(1) Identifies target and lays on target with proper range. Reports to commander CHECK, as prescribed in paragraph 9c(1) (i).

(2) Lays on target with proper lead.

(3) Fires until target is destroyed, new target designated, or CEASE FIRING is given.

(4) In shifts of over 800 mils, directs driver through inter-phone as to proper shifting of vehicle.

(5) Shifts fire to new target as directed by destroyer commander.

(6) Assumes command in the absence of destroyer commander.

c. Assistant gunner (loader).—(1) Loads the piece with ammunition indicated in fire order.

(2) Calls "Clear" after each loading and when he is clear of the path of recoil, and touches gunner with his foot.

(3) Inspects and prepares ammunition for loading. When firing HE shell, sets the fuze.

(4) Reports ammunition status.

(5) When gunner calls: "Misfire," checks to make certain breech is closed and gun is in battery, recocks gun, and reports: "Clear," when clear of path of recoil.

(6) Operates radio as directed by destroyer commander.

d. Assistant driver.—(1) Observes assigned sector and reports targets to destroyer commander.

(2) Starts auxiliary generator on order of destroyer commander.

(3) In absence of destroyer commander, takes post within machine-gun ring and operates radio as directed.

(4) Takes place of any crew member who is a casualty.

e. Driver.—(1) Keeps engine(s) running at 800 rpm and observes instruments.

(2) Takes over assistant driver's duties if he replaces a casualty.

(3) Keeps commander informed of fuel supply.

■ 47. DETAILED DUTIES IN FIRING (INDIRECT LAYING).—*a. Destroyer commander.*—(1) Indicates aiming point to gunner.

(2) Sets gunner's quadrant when it is used.

(3) When so ordered by higher commander, adjusts fire from forward position.

b. Gunner.—(1) Lays the gun for direction as directed by destroyer commander.

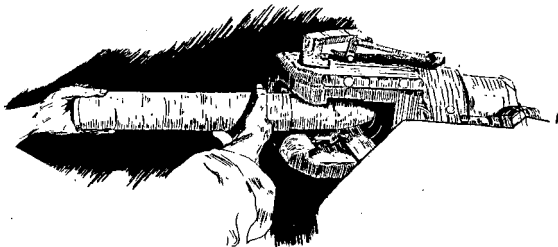

FIGURE 20.—Loading the gun.

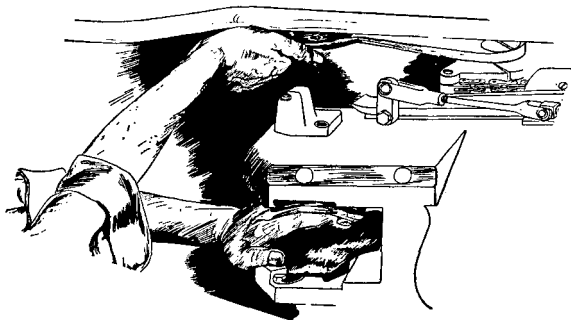

FIGURE 21.—Unloading an unfired round.

(2) Lays for elevation by leveling bubble of gunner's quadrant, under direction of destroyer commander.

(3) Sets deflection with aid of azimuth indicator.

(4) Makes designated corrections in deflection and elevation.

(5) Calls "Ready," and fires on command.

c. Assistant gunner.—(1) Loads the gun.

(2) In absence of destroyer commander, sets gunner's quadrant.

d. Assistant driver.—(1) In absence of destroyer commander, takes post within machine-gun ring and operates radio as directed.

(2) Performs duties as directed by destroyer commander.

(3) Puts out aiming stakes.

e. Driver.—(1) Places destroyer as directed by platoon leader.

(2) Stops engine.

(3) Performs duties as directed by destroyer commander.

■ 48. **TO SUSPEND FIRING.**—At the command **SUSPEND FIRING**, firing is stopped, gun if unloaded is reloaded, and made ready for instant resumption of fire. The gunner continues to lay on the target or lays on a new target as directed.

■ 49. **TO CEASE FIRING.**—Command: **CEASE FIRING.**—Duties are:

a. Destroyer commander.—(1) Orders the shifting of ammunition if required.

(2) Observes for new targets.

b. Gunner.—(1) Ceases firing.

(2) Turns firing switch to **OFF** position.

(3) Helps the assistant gunner to replenish the ready racks when directed by the destroyer commander.

(4) Observes for new targets to the front or traverses with the turret as directed by the destroyer commander.

c. Assistant gunner.—(1) Unloads the 76-mm gun, if loaded.

(2) Assisted by the gunner, replenishes the ready racks from the ammunition in the sponsons and places empty cases in sponson racks or throws them out of the turret when so directed. Empties the caliber .50 spent cartridge cases back into empty caliber .50 boxes and places them in rack. Shifts caliber .50 ammunition, if necessary.

(3) Reports ammunition status to destroyer commander.

d. Assistant driver.—Continues to observe sector assigned by destroyer commander.

■ 50. TO MOVE TO ALTERNATE OR SUPPLEMENTARY POSITION.—

a. Destroyer commander.—(1) Orders gun locked in desired position.

(2) Orders gun left loaded or unloaded.

(3) Directs driver to move to desired position.

b. Gunner.—(1) Traverses gun to position designated by commander.

(2) Locks turret lock.

c. Assistant gunner.—(1) Clears away empty shell cases.

(2) Unloads or loads as directed by commander.

d. Assistant driver.—Observes his assigned sector.

e. Driver.—(1) Prepares to move vehicle on orders of commander.

(2) On orders to move, inquires, "Is turret lock engaged?"

(3) Moves as directed upon receiving "Turret lock engaged."

■ 51. MARCH ORDER.—Command: MARCH ORDER. Duties are:

a. Destroyer commander.—(1) Supervises work of crew and receives their report.

(2) Places cover on AA machine gun.

(3) Checks that piece is locked in traveling position.

(4) Reports to next higher commander, "Destroyer march order. ——— rounds. ——— tanks fuel."

(5) Directs driver in proper direction.

b. Gunner.—(1) Places gun in traveling position and locks traveling lock.

(2) Assists in replacing breech cover.

(3) Disengages elevating mechanism.

(4) Locks turret lock.

(5) Opens traversing and firing switches.

c. Assistant gunner (loader).—(1) Checks bore to see that it is clear, closes breech, and reports "Bore correct."

(2) Replaces breech cover.

(3) Disposes of empty shell cases.

(4) Replaces and secures ammunition in ready racks.

(5) Reports to gunner, "——— rounds on hand."

d. Assistant driver.—(1) Removes periscope and places it in container.

- (2) Opens hatch.
- (3) Replaces muzzle cover.
- (4) Reports to commander, "Destroyer march order."
- (5) Remains alert to use available small arms.

e. Driver.—(1) Removes periscope and places it in container.

- (2) Checks fuel and lubricant gauges.
- (3) Reports to assistant driver, "—— tanks fuel."
- (4) Opens hatch.
- (5) On order to move, inquires, "Is turret lock engaged?"
- (6) Moves out as directed upon receiving "Turret lock engaged."

■ 52. DUTIES AFTER FIRING.—*a. Destroyer commander.*—(1) Supervises duties of crew.

(2) Inspects for lubrication, mechanical condition, and cleanliness, and causes all possible repairs and adjustments to be made.

b. Gunner.—(1) Inspects gun and mounting for any failures or looseness.

(2) Helps clean gun.

(3) If sight has not been accurate during firing, reports condition and boresights if necessary.

c. Assistant gunner.—(1) Swabs bore of gun.

(2) Checks recoil oil; refills or drains, if necessary.

d. Loader.—(1) Checks and reports ammunition to commander.

(2) Refills ammunition rack, inspecting rounds carefully for burs, dents, and other imperfections.

e. Driver.—Inspects vehicle for any failure or looseness.

NOTE.—The remainder of the crew will assist the driver in making repairs or adjustments as needed.

■ 53. DETAILED DESCRIPTION OF CERTAIN DUTIES.—*a. Action in case of engine fire.*—The first crew member to discover the fire calls, "Engine fire."

(1) The destroyer commander calls "Engine fire" loudly enough for the assistant driver and loader to hear him. At this command the assistant driver pulls one remote control fire switch and passes the hand extinguisher to the loader

who passes it on to the destroyer commander. The destroyer commander from the most convenient place supervises the extinguishing of the fire, making use of the remaining extinguisher system or the hand extinguisher if necessary.

(2) The gunner dismounts and takes hand extinguisher from assistant driver and hands it to the destroyer commander.

(3) The assistant gunner remains at his post, dismounting only when ordered by the destroyer commander.

(4) The assistant driver immediately pulls *one* fire extinguisher remote control handle located to the right rear of assistant driver's compartment. He pulls the second remote control handle when ordered by the destroyer commander. He then takes the hand extinguisher located in his compartment, hands it to the gunner, and dismounts.

(5) The driver stops the destroyer, if running, and races the engine. He dismounts only when ordered by the destroyer commander.

b. Action in case of air horn fire.—The first crew member to discover the fire calls: "Air horn fire." The driver stops the destroyer, if moving, and races the engine. If starting the engine, he continues to turn over the engine. Air horn fires generally occur while starting radial engines on cold mornings. They can be distinguished from engine compartment fires by the fact that the smoke will come from the exhaust and through the rear engine compartment openings. *So long as the flame is confined to the air horn the remote control extinguishers should not be used.* Should the foregoing procedure fail to extinguish the fire, an ax must be used to chop a hole in the air horn inlet, after which a hand extinguisher is used to put out the fire.

c. Action in case of crew compartment fire.—The first crew member to discover the fire, calls "Hull fire."

(1) If moving, the driver stops the destroyer and shuts off engine.

(2) The assistant driver takes hand fire extinguisher and extinguishes the fire or hands it to the assistant gunner if the fire is in the turret.

(3) The gunner traverses the turret as directed in order to help the assistant driver or the assistant gunner to use the hand extinguisher more effectively.

(4) The destroyer commander supervises the operation and gives the command to dismount from the destroyer when further progress is impossible.

(5) The assistant driver assists the driver.

■ 54. DISMOUNTED ACTION.—*a. To fight on foot.*—(1) At the command FIGHT ON FOOT, the destroyer commander designates the vicinity where the crew is to assemble, dismounts the caliber .50 machine gun from the ring mount, and hands it over the side to the assistant driver. The gunner removes the two carbines from the left hull side and the tripod from its carrying bracket. The assistant gunner hands out the remaining carbines, ammunition, and crew first aid kit. The dismounted destroyer crew perform the duties of their same numbers in the machine-gun squad. The dismounted crew moves by covered route to the position indicated, where the machine gun is mounted on the ground tripod and the crew, disposed for combat.

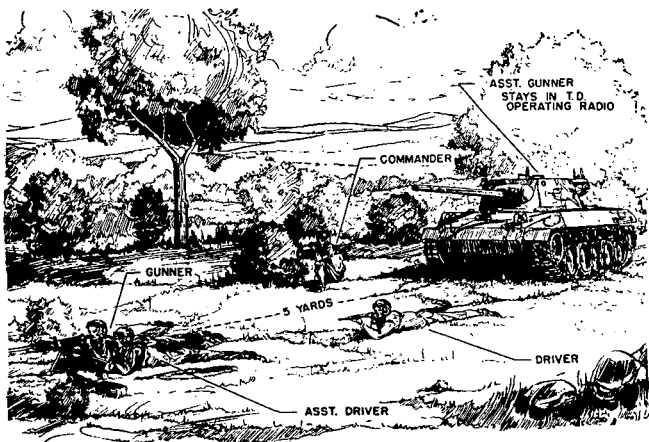

FIGURE 22.—Crew at FIGHT ON FOOT.

(2) For drill the machine gun is mounted 5 yards in front of the center of the destroyer and the crew takes posts as prescribed in FM 23-60. Minimum loads of ammunition are carried.

b. To remount destroyer after action.—At the destroyer commander's command **OUT OF ACTION, MOUNT**, the machine gun is taken out of action as prescribed in FM 23-60, the destroyer crew replaces weapons and ammunition in the destroyer, and mounts to positions as prescribed in paragraph 39.

c. To abandon destroyer.—At the command **ABANDON VEHICLE**, crew members follow the procedure prescribed in paragraph 54, except that before quitting the destroyer the commander displays the flag signal "Disregard my movements," and when appropriate the crew destroys its vehicle and equipment as prescribed in appendix II.

■ 55. **INSPECTIONS.**—*a. Vehicle.*—(1) The destroyer commander is responsible for inspections. He receives the reports from the various crew members relative to their individual inspections. He indicates in his report anything requiring work by maintenance personnel. In supervising first echelon maintenance he uses his discretion in delegating responsibilities to other crew members.

(2) The driver checks instruments, lights, siren, track suspension system, and engine performance in accordance with provisions of TM 9-755 and carefully prepares the Driver's Report, indicating required maintenance work. The assistant driver helps him with his inspections. Any irregularity noted by the driver and entered on his report, which is not repaired before the destroyer is used again, should be reentered on the report continually until it has been properly taken care of.

b. Weapons.—Prior to range or combat firing when weapons inspections is ordered, the routine is as follows:

(1) The destroyer commander checks operation and condition of the AA machine gun. He receives reports of crew members.

(2) The gunner disengages turret lock and checks the following: sight adjustment, elevating and power and hand traversing mechanisms, recoil oil, firing mechanism and ammunition in left sponsons; and reports "Gun correct. _____ rounds on hand."

(3) The assistant gunner checks the bore and reports to gunner "Bore correct"; checks ammunition in right sponson and ready clips and reports to gunner "_____ rounds on hand"; listens on radio net for orders.

(4) The assistant driver closes his hatch if open and adjusts periscope.

(5) The driver closes his hatch if open and adjusts periscope; starts engine throttling to 800 rpm; reads gauges; reports to assistant driver "_____ tanks fuel."

c. Radio and interphone.—A daily inspection prior to operation must be made by the destroyer commander of the cords and plugs for wear, moisture, and good contact, and should include the following:

(1) Checks antenna to determine that—

(a) Mast sections are tight and taped (or otherwise secured).

(b) Leads at transmitter, receiver, and mast base are tight.

(c) Mast base is tight and not cracked.

(d) Insulators passing through armor plate and bulkheads are not broken or displaced.

(e) Spare antenna sections and mast cover are properly stowed (replaces defective or lost sections).

(2) Checks radio set mounting, snaps, snubbers, and similar items for cleanliness and tightness.

(3) Checks to see that microphones and headsets are in good condition and in their proper places. Replaces all defective headsets and microphones from spares.

(4) Checks with driver to see that battery voltage is kept up. If voltage is low the auxiliary generator must be started. Has generator operated periodically when radio and interphone are operated continually while vehicle engine is not operating.

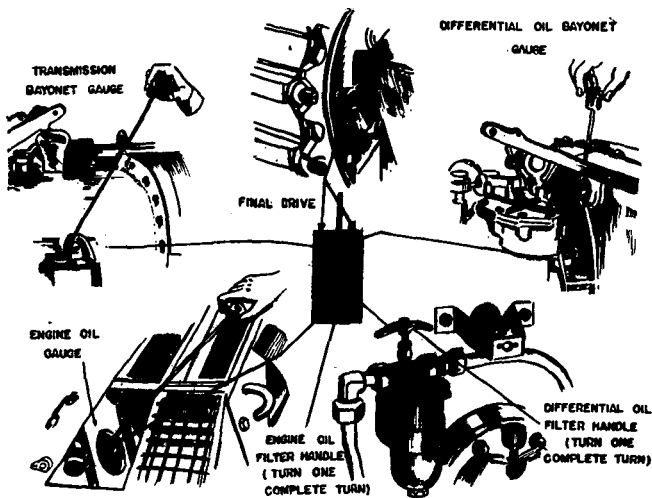

FIGURE 23.—First echelon maintenance—location to check oil level before operation.

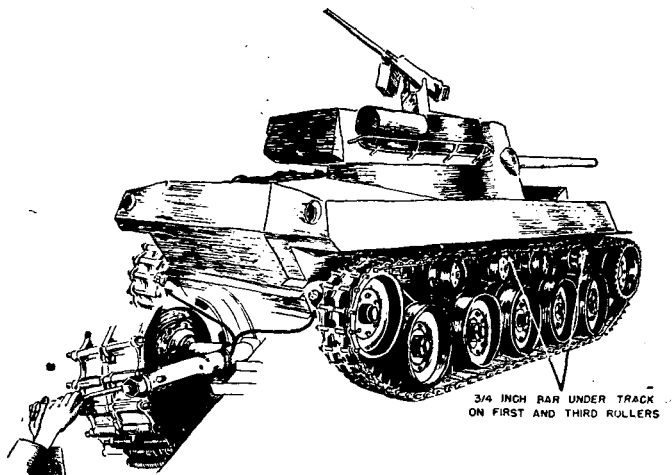

FIGURE 24.—First echelon maintenance—checking track adjustment.

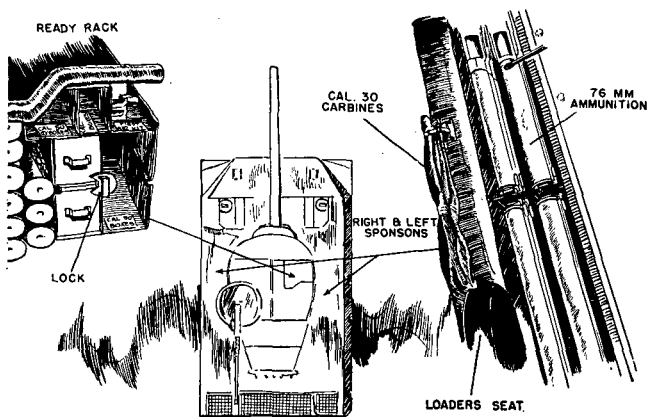

FIGURE 25.—Stowage of ammunition.

CHAPTER 5

TRAINING FOR PLACING ANTI-AIRCRAFT MACHINE GUN IN ACTION

■ 56. SCOPE.—This chapter covers training in placing the anti-aircraft machine gun in action. Mechanical functioning and manipulation are covered in FM 23-60 and 23-65.

■ 57. MOUNTS.—Mounts for the machine gun caliber .50, HB, M2, flexible, for anti-aircraft firing are:

- a. Skate track mount. (See fig. 26.)
- b. Skate ring truck mount. (See fig. 27.)
- c. Pedestal mount. (See fig. 28.)
- d. Pintle mount. (See fig. 29.)
- e. Concentric ring mount. (See fig. 30.)



FIGURE 26.—Skate track mount.

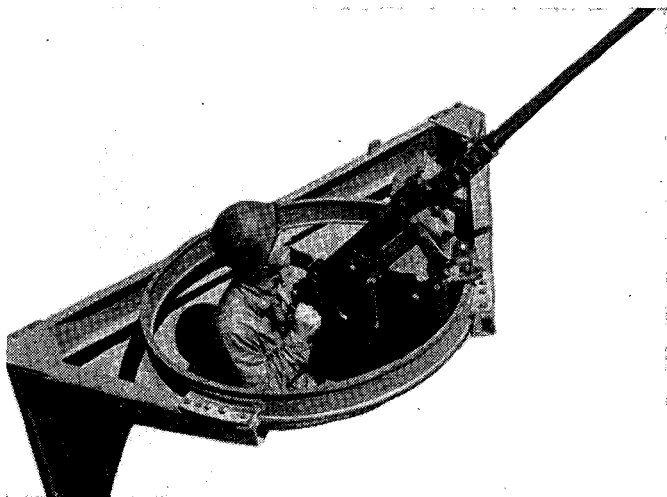

FIGURE 27.—Skate ring truck mount.



FIGURE 28.—Pedestal mount.

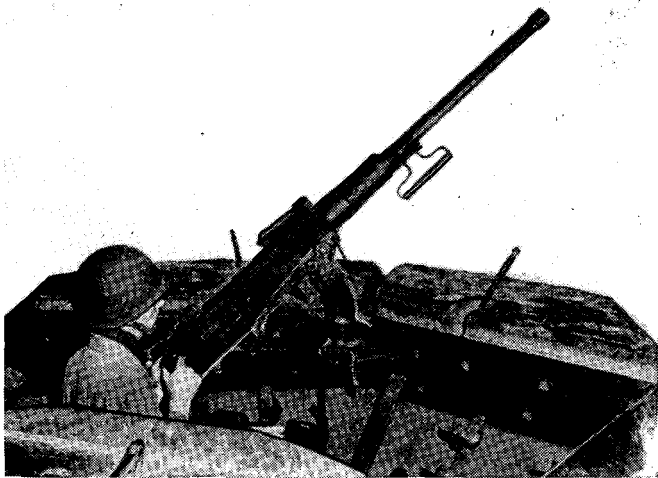

FIGURE 29.—Pintle mount.

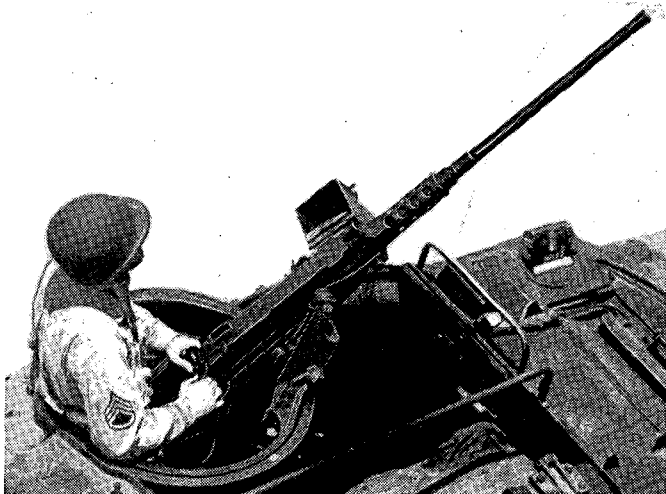

FIGURE 30.—Concentric ring mount.

■ 58. **COMPOSITION.**—Firing and care of the antiaircraft machine gun are accomplished by a member of the crew who is designated by the vehicle commander. He is referred to herein as machine gunner.

■ 59. **To EXAMINE EQUIPMENT.**—The machine gunner—

- a. Removes gun cover.
- b. Opens cover, locks bolt to the rear, and inspects chamber.
- c. Manipulates and inspects the following for adjustment, completeness, lubrication, and cleanliness:
 - (1) Head space adjustment.
 - (2) Feed mechanism. Sees that feed mechanism and bolt switch are properly adjusted to feed.
 - (3) Extractor.
 - (4) Retracting handle.
 - (5) Back plate group.
- d. Releases bolt.
- e. Sees that cover is closed and latched.

- f.* Presses trigger.
- g.* Sees that bolt release is fully latched down.
- h.* Examines spare barrel and spare parts chest and sees that—
 - (1) Bore of spare barrel is clear.
 - (2) Handle is securely attached to barrel.
 - (3) Contents of spare parts chest are complete and properly packed.
- i.* Examines ammunition chests and sees that—
 - (1) Cartridges are placed and aligned correctly.
 - (2) Links are clean.
 - (3) Belt is packed correctly in chest.
 - (4) Chest is latched.

■ 60. TO PREPARE FOR ACTION.—The machine gunner—

- a.* Moves to his post on gun. (See figs. 26 and 30.)
- b.* Removes gun cover.
- c.* Places one chest of ammunition on its support.
- d.* Inserts double loop of the link belt into feedway until first round is held by belt holding pawl.
- e.* Pulls retracting handle to the rear once, half loading gun.

■ 61. TO BRING FIRE AGAINST AIRCRAFT.—For detailed duties during firing see FM 4-151 and 23-60. After the gun has been prepared for action, duties of the machine gunner are:

- a.* Loads and fires when target is within tracer range.
- b.* The machine gun is held against the machine gunner's body which is directly behind and leaning into gun.
- c.* Fire is delivered in long bursts, controlled and adjusted by observation of the tracer stream (at the range of the target) rather than by use of gun sights.
- d.* Reduces stoppages.

NOTE.—When the 3-inch gun mounted on the M10 destroyer is in travel lock, a suitable position for the AA gunner is seated on the breech ring. When attacked by enemy aircraft the destroyer commander commands, AIR ATTACK. He then commands the driver, TURN RIGHT (LEFT). When the AA gun is pointing in the proper direction the gun commander commands STOP and the driver stops the vehicle.

■ 62. FIRING AT GROUND TARGETS.—For detailed duties during firing, see FM 23-60. After the gun has been prepared for action, duties of machine gunner are:

- a. Fires when gun is laid.
- b. Observes result of fire and makes necessary corrections.
- c. Reduces stoppages.

■ 63. TRAINING WITH GROUND MOUNT.—For training with ground mount, see FM 23-60.

CHAPTER 6

3-INCH TOWED GUN (GUN M5 AND GUN CARRIAGE M1)

| | Paragraphs |
|---|------------|
| SECTION I. General..... | 64-66 |
| II. Training for placing in action..... | 67-84 |
| III. Duties in firing..... | 85-94 |

SECTION I

GENERAL

■ 64. DESCRIPTION.—The 3-inch towed gun is a high velocity, flat trajectory weapon of the field gun type. It is the standard 3-inch antiaircraft gun M5 mounted on a split-trail carriage M1, similar to the 105-mm howitzer. This gun has two-man control and can be fired in either direct or indirect fire. It has a horizontal, sliding, wedge type breechblock, a traverse of 800 mils, and weighs 5,340 pounds in the firing position. It is a weapon which has tremendous striking power, firing either armor piercing (AP) or high explosive (HE) ammunition to ranges in excess of 12,000 yards. The prime mover currently authorized for the towed gun is the half-track personnel carrier M3.

■ 65. REFERENCES.—Details of care, operation, and maintenance of the gun and prime mover will be found in TM 9-322 and 9-710-A.

■ 66. DEFINITIONS AND TERMS.—*a. Coupled.*—A piece is said to be coupled when its lunette is attached to the pintle of a prime mover.

b. Uncoupled.—A piece is said to be uncoupled when its lunette is detached from the pintle of a prime mover and the trail rests on the ground.

c. Front.—The front, carriages coupled, is the direction in which the trail points; carriages uncoupled, the direction in which the muzzle of the piece points.

d. Right (left).—The direction right (left) is the right (left) of one facing the front.

e. In battery.—A gun is said to be in battery when it is in its normal firing position.

SECTION II

TRAINING FOR PLACING IN ACTION

■ 67. COMPOSITION OF GUN CREW.—A gun crew consists of a gun commander, a gunner, a driver, and seven cannoneers numbered from 1 to 7, and any additional cannoneers who are basics.

■ 68. FORMATION OF GUN CREW.—*a. Order of formation.*—A gun crew is formed as shown in figure 31. Basics, if present, form in order on the left of No. 7. Driver is the left flank man.

b. To form.—(1) The place of formation is indicated and the command given thus, for example; 1. IN FRONT (REAR) OF YOUR PIECES (OR ON THE ROAD FACING THE PARK), (2) FALL IN. *Each gunner repeats the command FALL IN* and hastens to place himself faced in the proper direction, at the point where the right of his squad is to rest. The cannoneers move at double time and assemble at attention in their proper places. For the first formation of the gun crews for any drill or exercise, the caution, "As gun crews," precedes the command. The gun commander, if present, supervises the formation.

(2) In case the front or rear of the carriage is designated, each gun crew falls in at its post (par. 69).

c. To call off.—(1) The command is: CALL OFF. The cannoneer on the left of the gunner calls off "One"; the cannoneer on the left of No. 1, "Two"; etc.

(2) After having called off, if a subsequent formation is ordered, the cannoneers fall in at once in their proper order.

■ 69. POSTS OF GUN CREWS—CARRIAGES COUPLED.—*a. In front of prime mover.*—The gun crew is in line facing to the front, its center three paces from the front of the prime mover.

b. In rear of the piece.—The gun crew is in line, facing the front, its center three paces from the end of the muzzle.

■ 70. To POST THE GUN CREW.—The gun crews having been marched to the vicinity of the carriages, are posted at the command: GUN CREWS IN FRONT (REAR) OF YOUR PIECES, MARCH. Each gunner marches his gun crew to its carriage and posts it in position indicated.

■ 71. To POST CANNONEERS.—*a.* The command is: 1. CANNONEERS, 2. POSTS. Each gunner repeats the command,

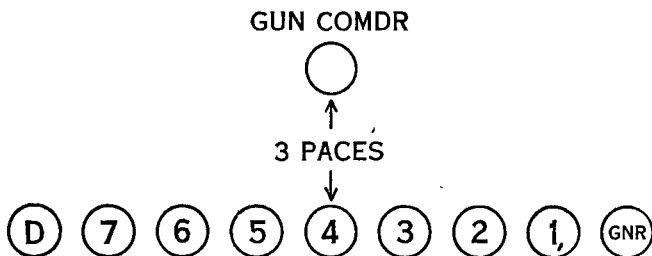

FIGURE 31.—Formation of gun crew.

POSTS. The cannoneers move at double time to their posts.

b. For preliminary instruction, the squads on entering the park are first posted with their carriages, and the cannoneers are then sent to their posts by the foregoing command. The command is general, however, and is applicable when the cannoneers are in or out of ranks, at a halt, or marching, and when the carriages are coupled or uncoupled.

■ 72 To MOUNT.—The command is: 1. CANNONEERS, PREPARE TO MOUNT. 2. MOUNT. At the first command, the cannoneers move at double time to positions shown in figure 32. At the second, the cannoneers of both columns mount in order from head to rear, and take seats as shown in figure 33. Each cannoneer is assisted by the one directly behind (or in front in the case of the last cannoneer in column) to insure promptness, and prevention of injuries. If the gun commander and

driver are to be included in the movement, the command is: 1. PREPARE TO MOUNT, 2. MOUNT. At the first command, the gun commander takes position 2 feet from the right side of the prime mover and opposite his seat; the driver takes position 2 feet from the left side of the prime mover and opposite his seat; each opens his door and faces to the front holding the door open. At the second command, they mount, take seats, and close their doors.

■ 73. To DISMOUNT.—The command is: 1. CANNONEERS, PREPARE TO DISMOUNT, 2. DISMOUNT. At the first command, the cannoneers assume standing positions facing the rear of the prime mover; at the second command, they jump to the ground and at the double time take posts as shown in figure 32. If the gun commander and driver are to be included in this movement, the command is: 1. PREPARE TO DISMOUNT, 2. DISMOUNT. At the first command, the gun commander and the driver unlatch their doors and hold them slightly open; at the second command, they promptly dismount, close their doors, and take posts as shown in figure 32.

■ 74. MOVEMENTS OF CARRIAGE BY HAND, COUPLED.—The carriages are not moved by hand when coupled.

■ 75. MOVEMENTS OF CARRIAGE BY HAND, UNCOUPLED.—*a.* The command is: 1. PIECES FORWARD (BACKWARD), 2. MARCH. At the first command, the gunner and No. 1 remove the trail lock pins and place them in the traveling positions. No. 2 and No. 6 on the left trail and No. 3 and No. 7 on the right trail manipulate the trails as directed by No. 4 so that the axle locks may be locked by No. 4 and No. 5, working on the left and right, respectively. Nos. 2, 3, 6, and 7 close the trails, and No. 6 assisted by No. 7 fastens the trail lock. The gunner and No. 1 release the hand brakes. No. 2 and No. 6, and No. 3 and No. 7 then grasp the trail handles on the left and right, respectively. No. 4 applies his weight to the muzzle, thus balancing the gun. The gunner and No. 1 place themselves at the left and right wheel, respectively, in moving forward. Basics, if present, are employed as directed by the gun commander. If the situation requires the use of drag ropes, Nos.

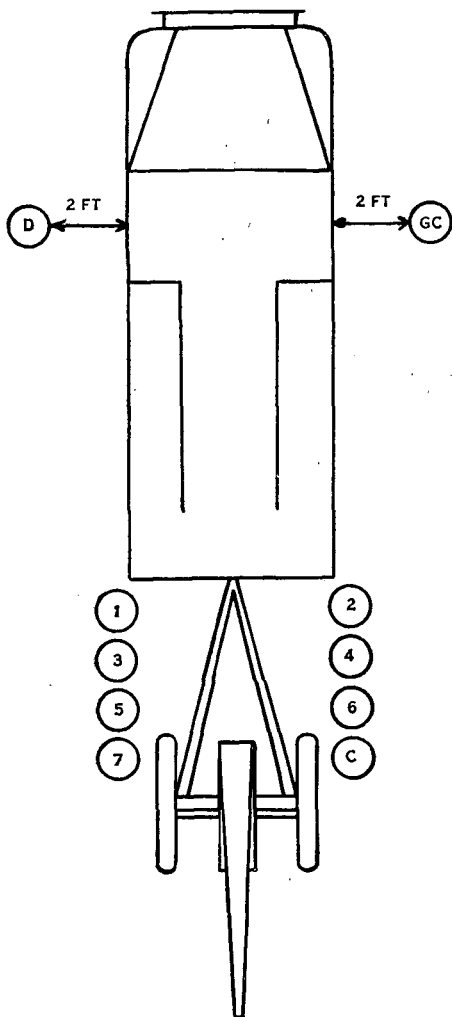

FIGURE 32.—Posts of cannoneers in PREPARE TO MOUNT.

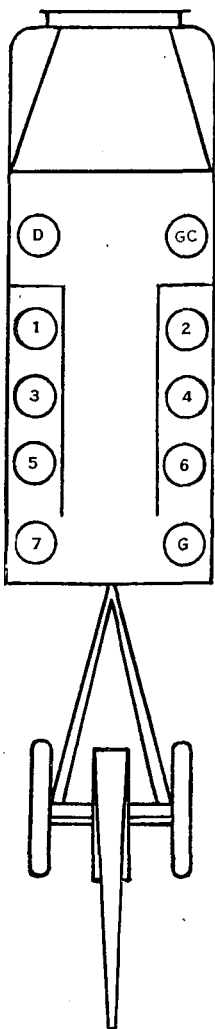

FIGURE 33.—Posts of cannoners MOUNTED.

4 and 5 under the direction of the gun commander will obtain the drag ropes and attach them to the hooks on the left and right axles, respectively. Personnel designated by the platoon commander to assist in the movement of the piece will take position and pull on the drag ropes as directed by the gun commander.

b. At the command **MARCH** all move the piece forward (backward) under the direction of the gun commander. When the piece is being moved up or down steep slopes, the gunner and No. 1 assist by alternately setting and releasing the left and right brakes, thus permitting the piece to be pivoted about the alternately locked wheels. At the command **HALT**, the piece is stopped and reestablished in the firing position; all resume their posts (par. 79).

■ 76. UNCOUPLING.—a. *General.*—At drills, prime movers are posted as directed by the company commander. In action and in training, the prime movers are conducted by the driver, the section sergeant, or the platoon sergeant to a place previously designated by the company commander, quickly available for movement and disposed to take the best advantage of cover and concealment. If no cover or concealment is available, the prime movers are located in rear of either flank, faced to the front, with wide intervals between them.

b. *To fire to front.*—The command is: **ACTION FRONT**. If marching, the prime movers halt at the command or signal. The cannoneers, if mounted, dismount after the prime movers have halted.

(1) *Pieces.*—The gunner and No. 1 hasten to the wheels nearest their respective posts. Nos. 2, 3, 6, and 7 hasten to the trail handles, even numbered cannoneers on the right, odd numbers on the left. Nos. 4 and 5 go to the muzzle of the piece and assist by placing their weight on the tube. No. 3 disengages the electric brake cable and safety chain from the prime mover. No. 2 unlatches the pintle and, assisted by Nos. 3, 6, and 7, raises the trail from the pintle; the gunner sets the left wheel brake. Nos. 2, 3, 4, 5, 6, and 7 swing the piece 180° clockwise, No. 3 releases the drawbar lock and turns the drawbar 180° latching it in

firing position. Nos. 2, 3, 6, and 7 then lower the trail to the ground. No. 1 sets the right wheel brake. The gunner and all cannoneers then unload the ammunition, tools, and accessories and arrange them in an orderly and convenient manner to the left of the piece. When the unloading has been completed, the gun commander commands or signals **DRIVE ON**. The gunner and cannoneers take their posts (par. 79).

(2) *Prime movers*.—At the command **DRIVE ON**, the prime movers move out and are conducted to their previously designated position.

c. To fire to the rear.—The command is: **ACTION REAR**. The movement is executed according to the principles of **ACTION FRONT**. The piece is not turned after uncoupling.

d. To fire to the flank.—The command is: **ACTION RIGHT (LEFT)**. The movement is executed according to the principles of **ACTION FRONT**, with the following modifications: After the piece is uncoupled, the trail is turned 90° away from the direction of fire, and the piece is run forward sufficiently to clear the track made by the prime mover; articles unloaded from the prime mover are placed on the ground so as to clear the track made by the prime mover.

■ 77. **COUPLING**.—*a*. The pieces being in position and in march order, the command is: **COUPLE**. The prime movers approach the position. As each prime mover approaches its piece, it turns to the left (right) and halts in prolongation of the trail of the piece.

b. All cannoneers working together under the direction of the gun commander, load the tools, accessories, and expended ammunition. Nos. 2, 3, 6, and 7 hasten to the trail handles, even numbered cannoneers on the left, odd numbered on the right. Nos. 4 and 5 hasten to the muzzle of the piece. The gunner and No. 1 release the brakes. The prime mover, upon signal from the gun commander, is maneuvered backward until the pintle is almost over the lunette. Nos. 2, 3, 6, and 7 then raise the trail and, after No. 3 has placed the drawbar in traveling position, place the lunette over the pintle, No. 2 latching the pintle. Nos. 4 and 5 assist by placing their weight on the tube. No. 3 engages

the electric brake cable and safety chain to the prime mover. The gun commander verifies that the brakes are operating properly. All cannoneers take their posts.

■ 78. TO PREPARE FOR ACTION.—*a.* The piece being in position uncoupled, the command is: **PREPARE FOR ACTION.** Duties of individuals are as follows:

(1) *Gun commander.*—(*a*) Supervises the work of the cannoneers.

(*b*) Inspects the matériel; verifies the fact that the recoil mechanism contains the proper amount of oil and that all is in order; and, when the operations have been completed, reports to the platoon commander, "Sir, No. (so-and-so) in order," or reports any defects that the crew cannot remedy without delay.

(2) *Gunner.*—(*a*) Assisted by No. 1, removes the breech end of the gun cover.

(*b*) Releases the left hand brake momentarily while trails are being spread to permit action of the equalizer axle.

(*c*) Places the left trail lock pin in the firing position.

(*d*) Removes the panoramic telescope from its case, and seats it in the telescope mount; or seats the telescope sight.

(*e*) Uncovers the telescope mount bubbles; sets the index of the rotating head at zero, the deflection at zero, and levels both bubbles, *when panoramic sight is used.*

(*f*) When using telescopic sight, levels cross level bubble only.

(*g*) Takes his post.

(3) *No. 1.*—(*a*) Assists the gunner in removing the breech end of the gun cover, throwing the cover to the right of the right wheel.

(*b*) Releases the right hand brake momentarily while trails are being spread, to permit action of the equalizer axle.

(*c*) Places the right trail lock pin in the firing position.

(*d*) Operates elevation handwheel to assist No. 4 in unlocking cradle lock.

(*e*) Operates the breech mechanism, and examines the breechblock, chamber, and bore, cleaning any parts requiring it, and leaves the breech open.

(f) When so directed by the platoon commander or gun commander, removes the elbow telescope from its case and seats it in its mount, if so equipped.

(g) Takes his post.

(4) No. 2.—(a) Spreads the left trail, assisted by No. 6, when No. 4 calls "Spread."

(b) Removes the rammer staff from its traveling position, assembles it to the rammer (bore brush), and places it to the right of the piece.

(c) When so directed, assists No. 1 in cleaning the breech mechanism, chamber, and bore of the gun.

(d) Folds muzzle and breech ends of the gun cover, and places them on the ground to the right of the right wheel of the gun.

(e) Takes his post.

(5) No. 3.—(a) Unlocks the drawbar lock, and turns and locks the drawbar in firing position.

(b) Spreads the right trail, assisted by No. 7, when No. 4 calls "Spread."

(c) Arranges the ammunition and tools, assisted by Nos. 4, 5, 6, and 7.

(d) Takes his post.

(6) No. 4.—(a) Unlocks the left axle lock from the traveling position and latches it in the firing position; when he sees that both axle locks are unlocked, calls "Spread," to inform Nos. 2 and 3 that trails may be spread.

(b) Unlocks the cradle lock, assisted by No. 1 operating the elevation handwheel, and latches it in firing position.

(c) Removes the muzzle end of the gun cover.

(d) When so directed, lowers left top shield and locks it in the lowered position.

(e) Assists No. 3 in arranging the ammunition and tools.

(f) Takes his post.

(7) No. 5.—(a) Unlocks the right axle lock from the traveling position and latches it in the firing position.

(b) Assists No. 4 to remove the muzzle end of the gun cover, and throws it on the ground to the right of the right wheel.

(c) Removes the aiming posts from the traveling position and places them beside the rammer staff.

(d) Assists No. 3 in arranging the ammunition and tools.

(e) Takes his post.

(8) *No. 6.*—(a) Unlocks the trail lock.

(b) Removes the trail hand spike from its traveling position and places it in its socket on the left trail.

(c) Assists No. 2 in spreading the left trail.

(d) Places the section chest immediately to the left of the piece when needed.

(e) Takes his post.

(9) *No. 7.*—(a) Assists No. 5 to spread the right trail.

(b) Assists No. 6 to place the section chest to the left of the piece.

(c) Assists No. 5 in arranging the ammunition and tools.

(d) Takes his post.

b. The coupled piece may be partially prepared for action before reaching the firing position. The duties of the cannoneers are the same as in preparing for action when the piece is uncoupled, but only such operations as are practicable are carried out. Immediately after the piece is established in position, preparation for action is completed without command, and the cannoneers take their posts for firing the piece.

c. If **PREPARE FOR ACTION** has not been ordered before the piece is established in the firing position, the command is habitually given by the gun commander as soon as the piece has been uncoupled. If this is not desired, the caution, "Do not prepare for action," must be given.

■ 79. **POST OF CANNONEERS, PIECE UNCOUPLED** (fig. 34).—*a.* The piece having been uncoupled, posts are taken as follows:

(1) *Gun commander.*—The gun commander goes where he can control the service of the piece, give commands, and observe the firing of his gun, usually about 5 yards to the flank.

(2) *Gunner.*—Immediately behind the left wheel and outside the trail.

(3) *No. 1.*—Immediately behind the right wheel and outside the trail.

(4) *No. 2.*—Three feet in rear of the gunner, covering him, and inside the trail.

- (5) No. 3.—Two feet to the left of No. 2.
 (6) No. 4.—Two feet in rear of No. 3, covering him.
 (7) No. 5.—Two feet to the left of No. 4.
 (8) No. 6.—Two feet to the left of No. 5.
 (9) No. 7.—Two feet in rear of No. 5, covering him.

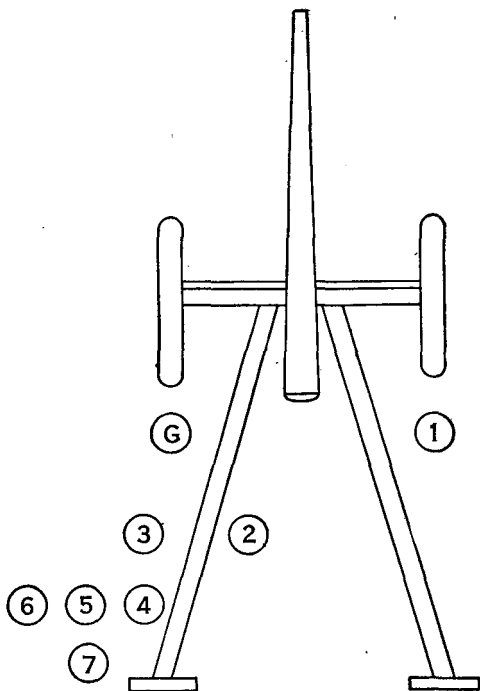

FIGURE 34.—Posts of cannoneers, gun uncoupled.

b. At drill, all stand at attention at their posts, facing the front. In firing and in combat, modifications of these posts' are required for the more efficient performance of the duties of the service of the piece and for the protection of the personnel. Basics, if present, take posts as prescribed by the gun commander.

■ 80. MARCH ORDER.—*a.* The gun being uncoupled and prepared for action, to resume the order for marching, the command is: MARCH ORDER. Duties of individuals are as follows:

(1) *Gun commander.*—(*a.*) Supervises the work of the cannoneers.

(*b.*) Inspects the matériel; makes sure that the piece is not loaded and that the traveling lock and cradle lock are locked in the traveling position; and, when the operations have been completed, reports to the platoon commander, "Sir, No. (so-and-so) in order," or reports any defects which the section cannot remedy without delay.

(2) *Gunner.*—(*a.*) Places the piece in the center of traverse.

(*b.*) Removes the left trail lock pin from the firing position and places it in the traveling position.

(*c.*) Sets the rotating head and deflection at zero and closes the covers on the telescope mount leveling bubbles.

(*d.*) Removes the telescope from the mount, returns it to its case, and locks the case.

(*e.*) Replaces the breech end of the gun cover, assisted by No. 1.

(*f.*) Takes his post.

(3) *No. 1.*—(*a.*) Operates elevation handwheel to assist No. 4 in locking cradle lock.

(*b.*) Removes the right trail lock pin from the firing position and places it in traveling position.

(*c.*) Inspects the chamber to see that the piece is unloaded and closes breech.

(*d.*) Assists the gunner in replacing the breech end of the gun cover.

(*e.*) Takes his post.

(4) *No. 2.*—(*a.*) Closes the left trail and locks the lock, assisted by No. 6.

(*b.*) Disassembles the rammer staff; removes the rammer (bore brush) and places it in the section chest; secures the rammer staff in its traveling position on the trail.

(*c.*) Takes his post.

(5) *No. 3.*—(*a.*) Closes the right trail, assisted by No. 7.

- (b) Turns and locks the drawbar in its traveling position.
- (c) Prepares ammunition and tools, assisted by Nos. 4, 5, 6, and 7, for loading in the prime mover.
- (d) Takes his post.
- (6) *No. 4.*—(a) Locks the cradle lock in the traveling position; No. 1 assists by operating the elevation handwheel.
- (b) Locks the left axle lock in the traveling position.
- (c) Raises and locks the top left shield, if down.
- (d) Replaces the muzzle end of gun cover, assisted by No. 5.
- (e) Assists No. 3 in preparing the ammunition and tools for loading in the prime mover.
- (f) Takes his post.
- (7) *No. 5.*—(a) Locks the right axle lock in the traveling position.
- (b) Secures the aiming posts in the traveling position on the trail.
- (c) Assists No. 4 in replacing the muzzle end of the gun cover.
- (d) Assists No. 3 in preparing the ammunition and tools for loading in the prime mover.
- (e) Takes his post.
- (8) *No. 6.*—(a) Assists No. 2 in closing the left trail.
- (b) Assisted by No. 7, locks trail lock.
- (c) Removes the trail hand spike from the left trail and secures it in its traveling position.
- (d) Prepares the section chest for loading in the prime mover, assisted by No. 7.
- (e) Assists No. 3 in preparing ammunition and tools for loading in the prime mover.
- (f) Takes his post.
- (9) *No. 7.*—(a) Assists No. 3 in closing the right trail.
- (b) Assists No. 6 in locking the trail lock.
- (c) Assists No. 3 in placing the drawbar in the traveling position.
- (d) Assists No. 6 in preparing the section chest for loading in the prime mover.
- (e) Assists No. 3 in preparing the ammunition and tools for loading in the prime mover.

(f) Takes his post.

b. *To resume fire in another position.*—(1) If firing is to be resumed shortly in another position to which the piece must be towed by its prime mover, the command MARCH ORDER is not given. In this case, at the command for coupling, only such of the operations incident to march order are performed as are necessary for the movement of the piece and for the care and security of the equipment.

(2) If the command MARCH ORDER is given while the piece is coupled, the operations pertaining to march order are completed.

■ 81. **CEASE FIRING.**—The command: **CEASE FIRING** normally is given to the gun squad by the gun commander, but in emergencies anyone present may give the command. At this command, regardless of its source, firing will cease immediately. If the piece is loaded, the commander will report that fact to the platoon commander. Firing is resumed at the platoon commander's announcement of the range and lead (deflection).

■ 82. **TO UNLOAD PIECE.**—a. When the command **UNLOAD** is given, No. 1 opens the breech slowly. No. 2 standing at the breech, receives the ejected round.

b. Should the extractor fail to eject the complete round, the assembled staff and rammer (or staff and unloading device, if available) is used. An officer sees that the recess in the head of the rammer is free from obstructions. Under the direct supervision of an officer, No. 1 inserts the rammer (or device) in bore until the head incloses the fuze and comes in contact with the projectile. He pushes and, if necessary, taps the rammer lightly with a wooden block until the round is dislodged from its seat. He then pushes it out of the breech; No. 2 receives it.

c. If the extractor has ejected the cartridge case but not the projectile, No. 1 fills the chamber with waste and closes the breechblock. He dislodges the projectile as prescribed in b above. No. 2 then opens the breech, removes the waste, and receives the projectile as No. 1 pushes it to the rear.

■ 83. MISFIRES.—In the event of a misfire, at least three attempts to fire the primer will be made. After at least 2 minutes have elapsed since the last attempt to fire the primer, the platoon commander will command: UNLOAD. The procedure is the same as in paragraph 82*b*. If the extractor ejects the round, the round will be disposed of as prescribed in TM 9-1900. If the extractor ejects only the shell case, the case will be immediately thrown clear of all personnel to prevent injury in case of hang fire, and then the projectile will be removed as prescribed in paragraph 82*c*.

■ 84. AMMUNITION.—Ammunition must be protected from damage, especially the rotating bands and shell cases. It is sorted and stored by lots. It is kept in containers as long as practicable. Whether in or out of containers, it is protected from dirt and ground moisture by being placed on paulins or raised off the ground. It is protected from sun and rain by a paulin or other shelter placed above it. To permit free circulation of air, wood or brush is placed between layers of unboxed rounds. If time permits, trenches for ammunition will be dug to minimize the effects of a direct hit. The ammunition is stacked with each stack containing not more than 100 rounds and being not more than 5 layers high. Stacks are at least 10 yards apart.

SECTION III

DUTIES IN FIRING

■ 85. GENERAL.—In general the duties in firing are as follows:

a. The gun commander is responsible that all duties are properly performed, all commands executed, and all safety precautions observed.

b. The gunner sets the announced deflection, lays for direction, and refers the piece.

c. No. 1 opens and closes the breech, and fires the piece.

d. No. 2 loads the piece.

e. No. 3 prepares the ammunition.

f. No. 4 assists No. 3 and passes the rounds to No. 2 for loading.

g. No. 5, assisted by Nos. 6 and 7, prepares the ammunition and passes the rounds to No. 4.

h. Nos. 6 and 7 remove ammunition from the containers and assist No. 5. No. 7 keeps empty shell cases out of the way of the cannoneers.

■ 86. GUN COMMANDER.—*a. Enumeration of duties.*—(1) To lay for elevation, assisted by No. 1, when the gunner's quadrant is used.

(2) To measure the elevation (range).

(3) (a) To measure the minimum quadrant elevation.

(b) To measure the minimum range (elevation).

(4) To indicate to the gunner the aiming point, the reference point, or the target.

(5) To follow fire commands.

(6) To indicate when the piece is ready to fire.

(7) To give the command to fire *except when firing on moving targets with direct laying.*

(8) To report errors and other unusual incidents of fire to the executive, or platoon commander.

(9) To record basic data.

(10) To observe and frequently check the functioning of the matériel.

(11) To assign duties when firing with reduced personnel.

(12) To conduct the fire of his piece on a moving target when so ordered by the platoon commander.

b. Detailed description of certain duties.—(1) *To lay for elevation when gunner's quadrant is used.*—(a) The command QUADRANT (SO MUCH) indicates that the gunner's quadrant is to be used.

(b) To set an elevation on the gunner's quadrant, for example of 361.8 mils, the gun commander sets the upper edge of the head of the index arm opposite the 360 mark of the graduated arc on the quadrant frame; he then turns the micrometer index head until it reaches the correct decimal reading.

(c) The announced elevation having been set on the gunner's quadrant, the piece is loaded, and the breechblock

closed, the gun commander places the quadrant on the leveling plates, with the words "line of fire" at the bottom and the arrow pointing towards the muzzle. The gun commander must be sure to use the arrow which appears on the same side of the quadrant as the scale which he is using. He stands squarely opposite the side of the quadrant and holds it firmly on the leveling plates parallel to the axis of the bore. It is important that he take the same position and hold the quadrant in the same manner for each subsequent setting, so that in each case he will view the quadrant bubble from the same angle.

(d) No. 1 operates the elevating handwheel until the quadrant bubble is centered, making sure that the last movement is in the direction in which it is most difficult to turn the handwheel. The gun commander warns No. 1 when the bubble is approaching the center, in order that the final centering may be performed accurately.

(2) *To measure elevation (range).*—At the command **MEASURE THE ELEVATION (RANGE)**, the piece having been laid, the gun commander causes No. 1 to set site 300 and with the elevating knob, to level the range quadrant elevating bubble. The gun commander then reads the elevation (range) set on the elevation scale (range drum) and announces the elevation (range) thus set; for example, "Elevation (range) No. (so-and-so), (so much)."

(3) *To measure minimum quadrant elevation or minimum elevation (range).*—(a) *Quadrant elevation.*—The command is: **MEASURE THE MINIMUM QUADRANT ELEVATION**. The gun commander, sighting along the lowest element of the bore, causes No. 1 to operate the elevating mechanism until the line of sight just clears the crest. He then measures the quadrant elevation and, after reading the angle on the quadrant, reports it to the platoon commander thus: "Minimum quadrant elevation, No. (so-and-so), (so much)."

(b) When the platoon commander announces the minimum quadrant elevation or the minimum elevation (range) the gun commander records it in a notebook and causes the gunner to chalk it on a convenient place on the carriage shield.

(4) *To indicate to gunner the aiming point, reference point, or target.*—Whenever an aiming point, a reference point, or a target has been designated by the platoon commander, the gun commander will make sure that he has properly identified the point in question. He will then indicate it to the gunner. If there is any possibility of misunderstanding, the gun commander will turn the telescope until the horizontal and vertical hairs are on the point designated.

(5) *To follow fire commands.*—The gun commander will follow the fire commands mentally. He will repeat the commands, and will be prepared to give any element of the last command to any cannoneer who has failed to hear it.

(6) *To indicate when piece is ready to fire.*—When the platoon commander can see arm signals of the gun commander, the gun commander will extend his right arm vertically as a signal that the piece is ready to fire. He gives the signal as soon as the gunner calls "Ready." When arm signals cannot be seen, the gun commander reports orally to the platoon leader, "No. (so-and-so) ready."

(7) *To give command to fire.*—When No. 1 can see arm signals made by the gun commander, the gun commander will give the command to fire by dropping his right arm sharply to his side. When his arm signals cannot be seen, he orally commands: NO. (SO-AND-SO) FIRE. The gun commander will *not* give the signal or command to fire until all the cannoneers are in their proper places. He will require the cannoneers to stand clear of the piece for the first round.

(8) *To report errors and other unusual incidents of fire to platoon commander.*—If for any reason the piece cannot be fired, the gun commander will promptly report that fact to the platoon commander, and the reason therefor; for example, "No. (so-and-so) out, misfire." Whenever it is discovered that the piece has been fired with an error in laying, the gun commander will report that fact at once; for example, "No. (so-and-so) fired with incorrect deflection." Whenever the gunner reports that the aiming posts are out of alignment with the telescope the gun commander will

report that fact and request instructions. Likewise, he promptly reports other unusual incidents that affect the service of the piece. (See par. 30.)

(9) *To record basic data.*—The gun commander will record in a notebook data of a semipermanent nature. These include such data as minimum elevations; base deflections, including aiming points used; prearranged fires when prepared schedules are not furnished; safety limits in elevation and deflection; number of rounds fired, with the date and hour; and calibration corrections when appropriate.

(10) *To observe and check functioning of matériel.*—The gun commander closely observes the functioning of all parts of the matériel during firing. Before the piece is fired, he verifies the fact that the recoil mechanism contains the proper amount of oil; thereafter he carefully observes the functioning of the recoil system. He promptly reports to the platoon commander any evidence of trouble.

(11) *To assign duties when firing with reduced personnel.*—Whenever the personnel of the section serving the piece is reduced the gun commander will make such redistribution of duties as will best facilitate the service of the piece.

(12) During direct firing on moving target, to conduct fire of his piece when so ordered by platoon commander.

(a) *Initial lead.*—The gun commander observes the target, estimates its lateral speed, and gives the gunner the number of leads to fire.

(b) *Initial range or elevation.*—The gun commander estimates the initial range to the target and announces the range to be fired. He should be trained to determine the range to various points in the sector at which enemy combat vehicles may be expected to appear. These are recorded and should be memorized by him. They are used in determining the initial range announced.

(c) To give a fire order. (See par. 9c.)

(d) The gun commander observes the fire by sensing the shots and calls the sensings to the gunner who will make necessary corrections.

■ 87. GUNNER.—*a. Enumeration of duties.*—(1) To center the bubbles on the telescope mount.

(2) To set the deflection.

(3) To lay for direction.

(4) To call "Ready."

b. Detailed description of certain duties.—(1) *To set deflection.*—At the command, for example: DEFLECTION 1,885 MILS, the gunner first sets the zero or the azimuth micrometer opposite the fixed index, if it is not already so set. He then uses the throw-out lever and turns the rotating head until the hundreds graduation (18 in this case) is opposite the azimuth scale index. He then releases the throw-out lever, and grasping the deflection knob with his left hand, thumb on top, turns the knob to the left until the micrometer index is opposite the graduation 85 of the counterclockwise graduations on the azimuth micrometer. The line of sight will then make a horizontal angle of 1,885 mils with the axis of the bore. He then turns the azimuth micrometer scale until the zero graduation is opposite the micrometer index. Any movement of the azimuth micrometer scale does not change a deflection previously set.

(2) *To lay for direction—indirect laying.*—The deflection having been set, the gunner brings the vertical hair of the panoramic sight on the aiming point by traversing the piece. If the amount of movement necessary is greater than can be obtained by traversing, the trails must be shifted. (When shifting trail the same wheel must be kept locked at all times.)

(3) *To call "Ready."*—The piece having been laid for direction, and No. 1 having called "Set," the gunner verifies the laying, checks that the sight mount bubbles are level, moves his head clear of the sight, and calls "Ready" to indicate the piece is ready to be fired.

■ 88. No. 1.—*a. Enumeration of duties.*—(1) (a) To open and close the breech.

(b) To call "Set."

(c) To fire the piece.

(d) To use the rammer.

(2) For direct firing on a moving target, No. 1 performs the duties prescribed in (1) above.

b. Detailed description of certain duties.—(1) *To open and close breech.*—(a) *To open breech.*—No. 1 grasps the breech operating lever handle, pushes down on the handle to release the catch, and draws it toward him and to the rear, opening the breech.

(b) *To close breech.*—No. 1 grasps the operating handle and pushes it forward and away from him until the breech is closed and the latch has engaged.

(2) *To call "Set."*—No. 1 calls "Set" when the piece has been loaded, the breech closed, and the quadrant elevation is set on the gun.

(3) *To fire the piece.*—In indirect laying, at the gun commander's command NO. (SO-AND-SO) FIRE, and in direct firing on a moving target, at the gunner's command FIRE, No. 1 grasps the handle of the lanyard and pulls it away from the piece as far as possible. When the gun commander gives the command STAND CLEAR (for the first round), No. 1 steps clear of the wheel and at the command or signal FIRE, leans forward, grasps the handle of the lanyard, and fires the piece. If the gun commander commands WITH THE LONG LANYARD, No. 1 attaches the long lanyard to the short lanyard and fires as previously described.

■ 89. No. 2.—*a. Enumeration of duties.*—(1) To load the piece.

(2) When necessary, assists in shifting the left trail.

(3) To inspect the chamber and bore frequently to find out whether there is any residue in the bore.

b. Detailed description of certain duties.—(1) *To load the piece.*—To receive the round, No. 2 steps with his left foot toward No. 4 and grasps the round with his right hand, at the base of the shell case and his left hand in front of the rotating hand. After resuming his position facing the gunner, he inserts the round in the breech and pushes it home with his right hand. He must use care, especially at higher elevations, to avoid injuring his right hand. When necessary to insert his hand into the breech recess, to push the round

home, he should first close his fist. No. 2 will be particularly careful to avoid striking the fuze against any portion of the piece. To prevent premature bursts caused by fuzes in projectiles being struck by the piece in the recoil, a round to be loaded will be held well out of the path of the recoil until the gun is again in battery (AR 750-10).

(2) *To inspect chamber and bore frequently to find out whether there is any residue.*—No. 2 will inspect the chamber and bore frequently, particularly when firing at low elevations, to make certain that no residue, which may cause jamming of the round in loading, remains in the chamber of the bore.

■ 90. No. 3.—*a. Enumeration of duties.*—(1) To make the prescribed setting of impact fuzes.

(2) When necessary, assists No. 5 in shifting the right trail.

b. Detailed description of certain duties.—(1) *To make prescribed setting of impact fuzes.*—(a) The fire commands for opening fire will contain a designation of the setting desired, when the prescribed fuze can be given more than one setting.

(b) If the command is FUZE QUICK, No. 3 will verify the setting, and reset to QUICK any fuzes which may be set on DELAY.

(c) After firing is completed, No. 3 will reset to QUICK any fuzes which have been set DELAY.

(2) *When necessary, to assist No. 5 in shifting right trail.*—No. 3 assists No. 5 in shifting the right trail as directed by the gunner.

■ 91. No. 4.—*a. Enumeration of duties.*—(1) When directed by the gunner, to lower the left top shield and lock it in position.

(2) To pass ammunition to No. 2.

(3) To assist No. 3 in preparing ammunition.

b. Detailed description of certain duties.—(1) When directed by the gunner, to lower left top shield and lock it in position. When the fire commands are such as to require an

aiming point (reference point) to the front, No. 4, when directed by the gunner, will promptly lower the left top shield and lock it in the lowered position.

(2) *To pass ammunition to No. 2.*—No. 4 with his left hand under the cartridge case, his right hand under the projectile, passes the round to No. 2 so that No. 2 is able to grasp the base of the cartridge case in his right hand.

(3) Assists No. 3 in preparing the ammunition.

■ 92. No. 5.—*a. Enumeration of duties.*—(1) To prepare ammunition before firing.

(2) To pass the round to No. 4.

b. Detailed description of certain duties.—(1) No. 5 will prepare the ammunition before firing by cleaning and checking to see that there are no rough edges on the round.

(2) *To pass the round to No. 4.*—No. 5 will pass the round to No. 4 in the most convenient manner.

■ 93. No. 6.—*a. Enumeration of duties.*—(1) To remove ammunition from container.

(2) To assist No. 5 in preparing ammunition.

(3) When necessary, assisted by No. 2, shifts left trail.

b. Detailed description of certain duties.—(1) *To remove ammunition from containers.*—Assisted by No. 7, No. 6 removes the rounds from their containers and arranges them so they are within easy reach of No. 5. He inspects each round to see that it is free from sand and dirt and that the rotating band is not burred. With an oily cloth he wipes off any foreign matter. Projectiles with burred rotating bands should be placed aside until he can remove the burs with a file.

(2) When necessary, assisted by No. 2, shifts left trail at the command of the gunner.

■ 94. No. 7.—*a. Enumeration of duties.*—(1) To assist No. 6 in removing ammunition from containers.

(2) To assist No. 5 in preparing ammunition.

(3) To keep empty shell cases out of the way of the cannoneers.

(4) When necessary, assisted by No. 3, shifts the right trail.

b. Detailed description of certain duties.—(1) To assist No. 6 in removing ammunition from containers. No. 7 assists No. 6 in removing rounds as described in paragraph 93b(1).

(2) To assist No. 5 in preparing ammunition as described in paragraph 92b(1).

(3) To keep empty shell cases out of the way of cannoners. No. 7 piles the empty shell cases in rear of the right trail where they will be out of the way of the cannoners.

(4) When necessary, assisted by No. 3, to shift right trail when so directed by the gunner.

CHAPTER 7

COMBAT FORMATIONS

■ 95. COMBAT FORMATIONS.—*a. General.*—These formations may be used for the march, for cross-country movement, and when entry into action is imminent.

b. Battalion and company.—(1) *Column* (fig. 36).—Whenever possible vehicles avoid following in trace. Interventricular distances are about 100 yards.

(2) *Echelon right (or left)* (fig. 36).—Units are echeloned (staggered) to the flank indicated, the rear unit being farthest to the flank. Units move to the left front (right front) or left flank (right flank) until in place; the leading unit continues the march to its front or remains halted.

(3) *Wedge* (fig. 36).—The second and third units are echeloned in depth and to the left and right of the leading unit, respectively.

(4) “V” (fig. 36).—An inverted wedge.

c. Reconnaissance platoon.—The reconnaissance platoon seldom operates in formation other than column.

d. Reconnaissance section.—(1) *Column* (fig. 37).—(See b(1) above.)

(2) *Wedge* (fig. 37).—(See b(3) above.)

(3) “V” (fig. 37).—(See b(4) above.)

e. Pioneer platoon.—Formations are similar to those of reconnaissance platoon.

f. Tank destroyer platoon.—(1) *Column* (fig. 38).—Order of march: the $\frac{1}{4}$ -ton vehicle preceding or to the flank, reconnoitering and observing at a distance of 500 yards or more, utilizing terrain; the platoon commander's destroyer; security vehicle; second, third, and fourth destroyers. The last destroyer tows the ammunition trailer when contact is imminent; the trailer may be left in a concealed position when action is begun.

(2) *Wedge* (fig. 38).—Same as column except that the second and third destroyers are echeloned to the left and

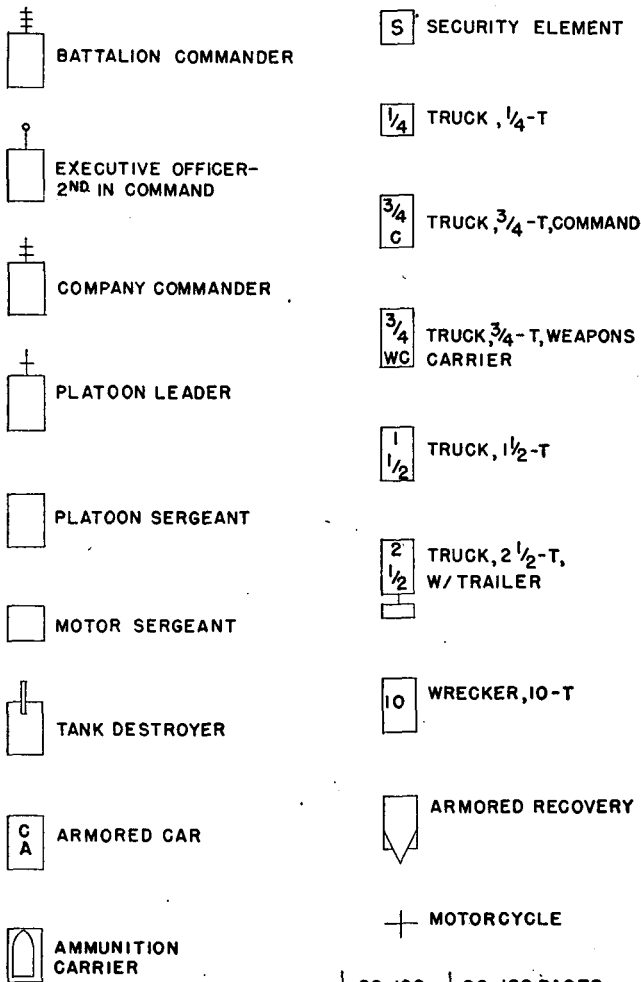

←20-100→ 20-100 PAGES

FIGURE 35.—Legend.

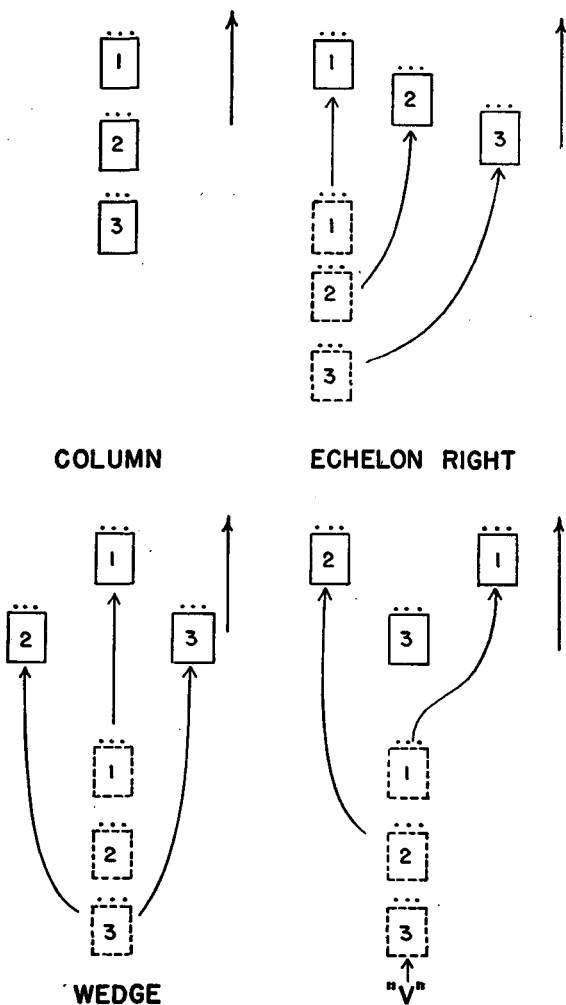

FIGURE 36.—Tank destroyer company.

right, respectively. Width of the wedge may vary from a staggered column to 200 to 300 yards.

g. Headquarters company.—(1) Headquarters company usually will march in column or extended column.

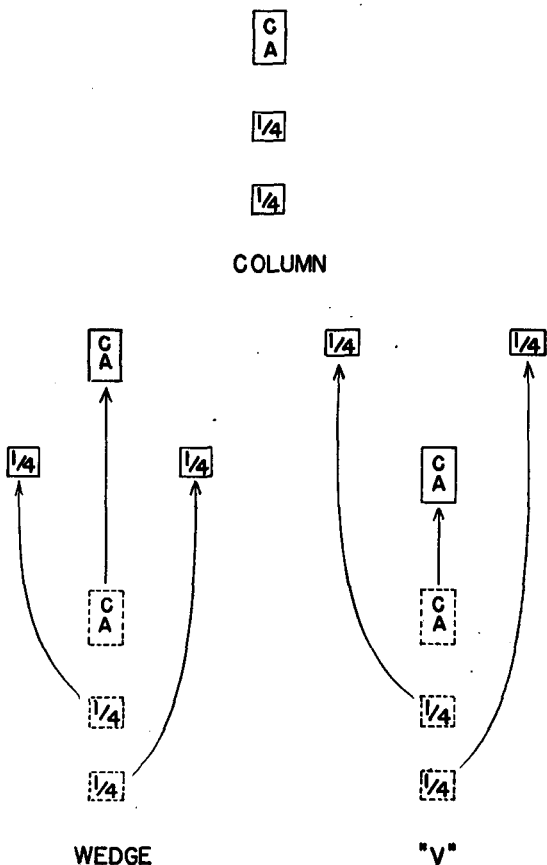

FIGURE 37.—Reconnaissance section.

(2) *Platoon formations.*—(a) Column.

(b) Vehicles echelon right (left).

(3) *Company formation.*—See figure 39.

h. Medical detachment.—(1) The formations are:

(a) Column.

(b) Detachment echelon right (left).

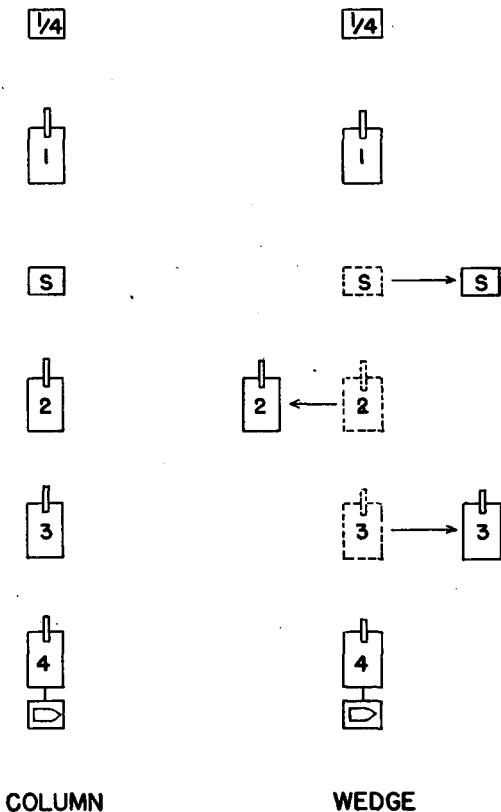

FIGURE 38.—Tank destroyer platoon.

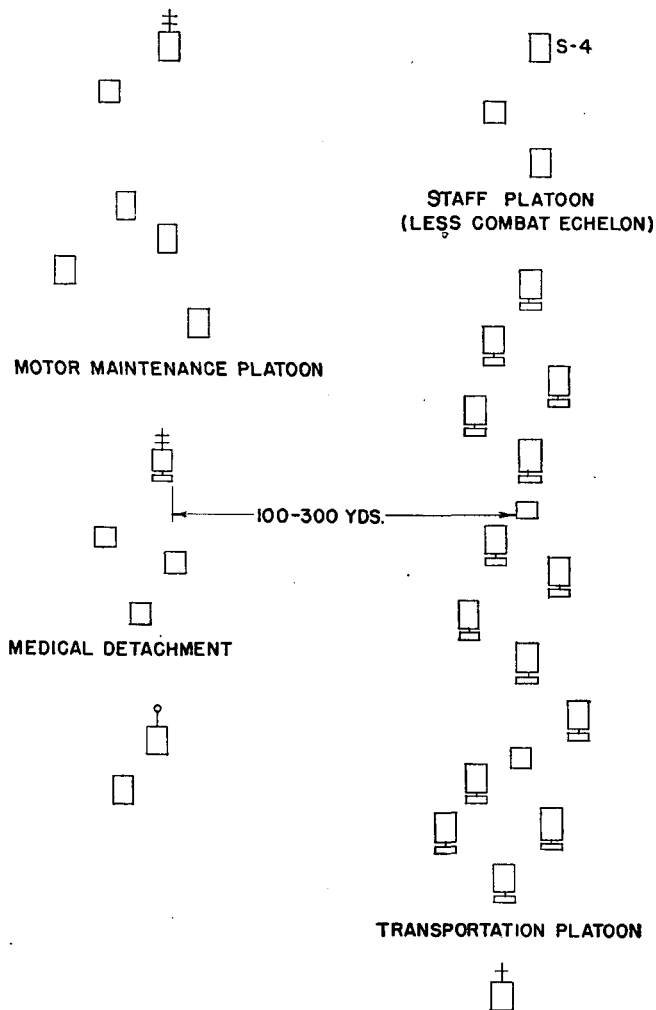

FIGURE 39.—Headquarters company, extended formation.

(2) For details of drill for medical detachment see FM 8-5.

i. Tank destroyer battalion.—A formation for a tank destroyer battalion operating alone is shown in figure 40.

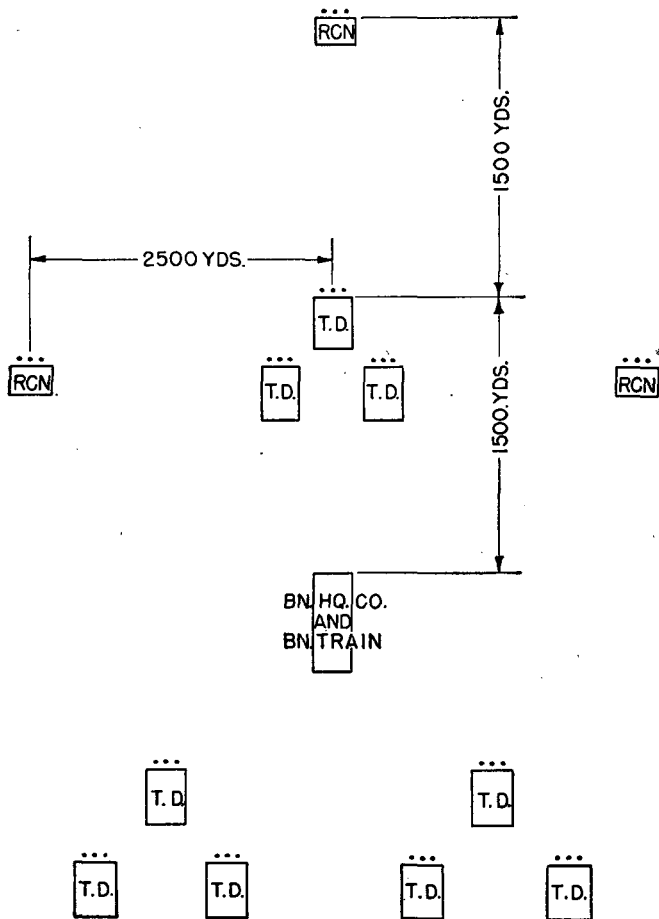

FIGURE 40.—Battalion operating alone (not to scale).

CHAPTER 8

CEREMONIES AND INSPECTIONS

| | Paragraphs |
|---------------------------------------|------------|
| SECTION I. General | 96-97 |
| II. Reviews and other ceremonies..... | 98-109 |
| III. Inspections | 110-113 |

SECTION I

GENERAL

■ 96. **PURPOSE.**—*a. Ceremonies.*—Ceremonies inspire military spirit, enhance the morale of troops, and aid in disciplinary training. Reviews usually are mounted, parades dismounted. Escorts may be either mounted or dismounted. For parades the appearance and movement of troops in formation being primary considerations, the dismounted ceremony is considered desirable. Each formation should be precise; each movement should be executed with precision and dispatch.

b. Inspections.—Formal inspections are held to determine the completeness, serviceability, and appearance of individual and organizational equipment and to judge the unit's general appearance and smartness.

■ 97. **DISMOUNTED DRILLS AND CEREMONIES.**—Precise, short, snappy, dismounted drills develop smartness. Dismounted ceremonies conform generally to provisions of FM 22-5.

SECTION II

REVIEWS AND OTHER CEREMONIES

■ 98. **GENERAL.**—*a.* A review is a ceremony tendered to a civilian or military official or to a foreign dignitary. A review may also be held for the purpose of presenting decorations or making a general inspection.

b. Tank destroyer reviews are ordinarily mounted.

■ 99. ROAD REVIEWS.—*a.* Road reviews save time and afford the same opportunity to observe condition of the command as one held on a field. Instructions are issued for control of traffic, safety precautions, markers, and guides. Rates of march and distances between units and vehicles are prescribed. Provision is made for diverging units after passing the reviewing stand to prevent jamming.

b. The unit forms in a column of vehicles at least 1,000 yards from the reviewing officers, with 5 yards distance between vehicles and 10 yards between companies; halted, motors are cut.

c. When the road permits, motorcycles are massed in columns of four at the head of each battalion.

d. Other vehicles usually are formed in columns of two. The number of columns will be the maximum permitted by the width of the road.

e. Standards are carried in a command car or other suitable vehicle, escorted by a motorcycle on each side of the car, in the rear of the color company. (See fig. 41.)

f. Unit commanders report by radio when their commands are ready to move out. If the reviewing officer decides to inspect units before the passing in review, he so indicates and the unit is notified. As the reviewing officer approaches, each battalion and company commander salutes. As soon as the inspection is completed, the unit is mounted.

g. When the command or signal to pass in review is given, companies move out so as to pass the reviewing officer at the prescribed rate of speed, and with the prescribed distances between vehicles and units.

h. Twenty-five yards is the usual distance between platoons, 50 yards between companies, 100 yards between battalions, and 200 yards between groups. The distance between vehicles is 15 yards at speeds generally between 15 and 20 miles per hour. Changes of speed must be gradual. Preservation of distances between vehicles will take precedence over distances between units.

i. Drivers must be careful to prevent jamming at the reviewing stand, and should pass any vehicle that is unable

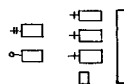
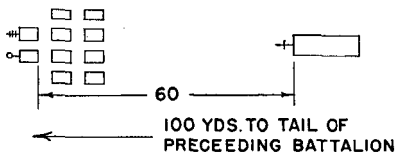

FOR LEGEND SEE FIGURE 35

INTERVALS AND DISTANCES
IN PACES.

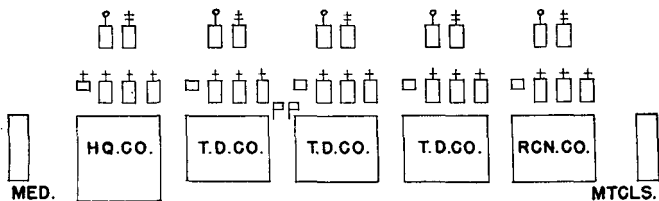
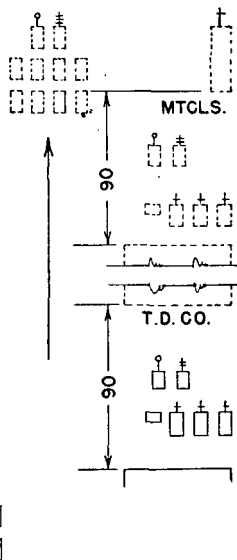

FIGURE 41.—Tank destroyer battalion as part of a large review.

to keep its place in column. Such vehicles should pull well over to the side of the road (off the road when practicable); the senior in the vehicle signals others to pass.

■ 100. FIELD REVIEW.—The review consists of four parts—

- a. Formation of troops and transportation.
- b. Presentation and honors.
- c. Inspection by passing around the troops.
- d. March in review.

■ 101. COMMANDER OF TROOPS.—See FM 22-5.

■ 102. PREPARATIONS.—a. The line on which the troops are to form is marked or designated. The post of the reviewing officer and line of march are marked with flags.

b. The reviewing stand and markers are so placed that the right of each line may pass the reviewing stand at 20 yards. For group and battalion reviews, the line of troops is about 120 yards in front of the reviewing stand. In larger reviews the line of group commanders is about 120 yards in front of the reviewing stand.

■ 103. RULES FOR PERSONNEL AT MOUNTED REVIEWS.—a. Personnel dismount after the vehicles are halted in the initial formations. Officers form six paces directly in front of their vehicles. Other personnel form in a line at close interval with the right flank three paces in front of the right front wheel of their respective vehicles; a single line is formed if there are five or fewer men; men in excess of five form a second rank. Dismounted riflemen form with their weapons carried slung.

b. Movement from dismounted posts to mounted posts and the reverse is executed at *double time*.

c. When mounted in armored vehicles, officers stand. Officers salute as they pass the reviewing officer.

d. Noncommissioned officers commanding platoons follow the same rule concerning saluting as for officers.

e. Personnel other than officers, drivers, and riflemen riding in open vehicles, sit at attention with their hands in their laps. Only men seated and facing in the direction of move-

ment of the vehicles turn their heads at the command 1. EYES, 2. RIGHT; all others remain at attention.

f. Vehicular weapons are mounted on their vehicular mounts with covers off. Machine guns, except antiaircraft, are adjusted and clamped with barrel horizontal and pointed in line with axis of the vehicle. Antiaircraft guns are pointed to the left and upward at maximum elevation. Men armed with rifle not carried in scabbard will hold the piece vertically with both hands, barrel to rear, butt resting on floor between the feet.

g. Motorcycle windshields are usually removed. Leg shields are ordinarily used.

h. When posted with the organization commander, dismounted, guidon is one pace to his rear and three paces to his left. When the commander is in a vehicle the guidon is flown therefrom.

■ 104. STANDARDS.—*a.* At mounted formations in which standards are carried they are mounted on a command car or other vehicle. The standard bearer and standard guards ride in this vehicle. In a line formation, the vehicle carrying the standard is on the left of the color company, on line with the front ranks of vehicles. (See fig. 41.) In column formation the vehicle carrying the standard is in rear of the color company. This vehicle is accompanied by two solo motorcyclists, each 2 yards to the side of and abreast of the front of the vehicle.

b. At ceremonies when troops are formed dismounted the standards are removed from the vehicle and posted in the dismounted line. When the troops are presented to the reviewing officer, the organizational standard is dipped when the rank of the officer entitles him to the salute. (See AR 600-30.)

■ 105. MUSIC.—At mounted ceremonies the music is formed dismounted 30 paces to the left and 6 paces in rear of the reviewing officer. When more than one band is present, additional band or bands form on the left of the first. Bands may be massed. The band plays while the reviewing officer

is inspecting the troops and during the march past the reviewing stand.

■ 106. INITIAL FORMATIONS.—*a.* Line of company masses is the usual initial formation. (See fig. 41.) Tank destroyer groups may form in line of battalions, the battalions being in column of company masses. Battalions, when in review with other units, may form in column of company masses.

b. Motorcycles usually are formed into a provisional platoon on the right of the battalion.

c. Because of the diversity of the types of vehicles within companies, it is necessary to form provisional platoons within each company in order to present a more nearly balanced formation. Suggested formations for companies are shown in figures 42, 43, and 44.

d. The initial formation is taken and all troops are in position prior to adjutant's call or, in the case of larger reviews, the sounding of attention.

■ 107. REVIEWING PARTY, PRESENTATION AND HONORS, AND INSPECTION.—See FM 22-5.

■ 108. MARCH IN REVIEW.—*a.* (1) *Intervals.*—Six paces between vehicles.

(2) *Distances.*—Between group and separate units—150 paces; between battalions—120 paces; between companies—90 paces.

(3) For distances maintained by commanders, see figures 41, 42, 43, and 44.

b. When the reviewing officer has resumed his post after the ride around or when he indicates he does not desire to ride around the troops, the commander of troops commands or signals: 1. PREPARE TO PASS IN REVIEW, 2. MOUNT. All personnel move at the double time and mount. Engines are started.

c. The commander of troops commands or signals: PASS IN REVIEW.

d. Movements to pass in review from a mass formation are:

(1) *Column right.*—Executed successively by companies at the command PASS IN REVIEW.

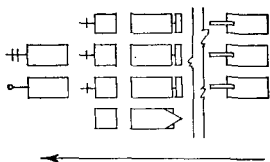

FOR LEGEND SEE FIGURE 35
 INTERVALS AND DISTANCES
 IN PAGES.

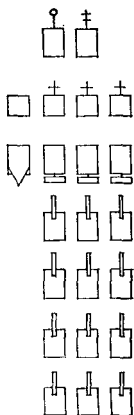
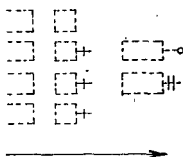
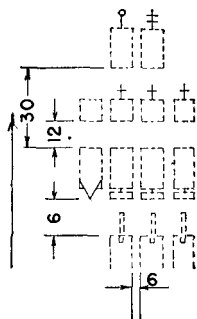

DISTANCES - 6 PAGES BETWEEN
 LONGEST VEHICLES.

INTERVALS - 3 PAGES.

FIGURE 42.—Headquarters company.

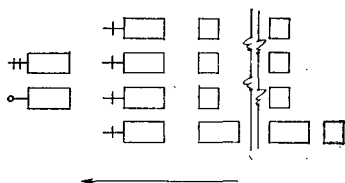

FOR LEGEND SEE FIGURE 35
INTERVALS AND DISTANCES
IN PAGES.

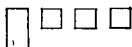
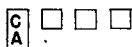
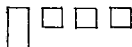
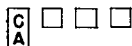
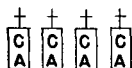
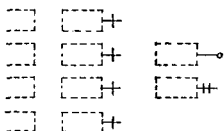
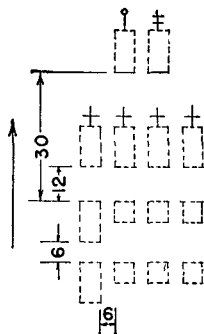

DISTANCES - 6 PAGES BETWEEN
LONGEST VEHICLES.

INTERVALS - 3 PAGES.

FIGURE 43.—Reconnaissance company.

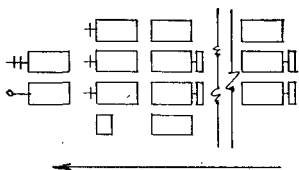

FOR LEGEND SEE FIGURE 35

INTERVALS AND DISTANCES
IN PAGES.

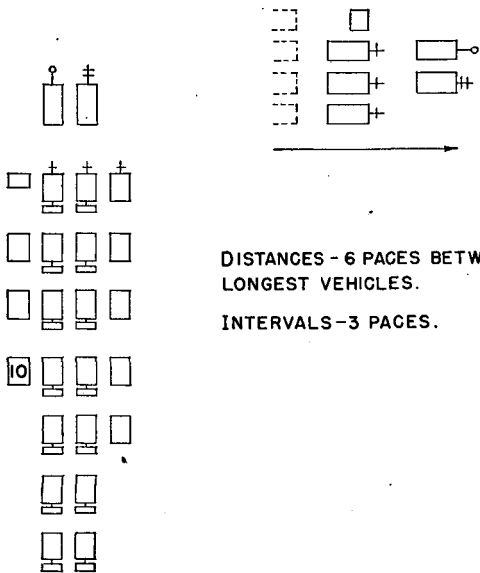
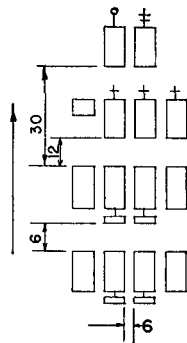

DISTANCES - 6 PAGES BETWEEN
LONGEST VEHICLES.

INTERVALS - 3 PAGES.

FIGURE 44.—Tank destroyer company.

(2) *Column left.*—Executed successively by companies in order to make the next change of direction at the end of the review field.

(3) *Column left.*—Executed successively by companies to make the last change of direction.

e. Other formations and movements may be prescribed by appropriate commanders.

f. In case the initial formation is in column of masses or other column formation, each rear basic review unit moves to the front after the units ahead have cleared; it then executes the prescribed column movements to pass in review on the same ground as the leading unit in its column. The speed for the review is prescribed by the commanding officer and should be approximately 10 to 15 miles per hour.

g. Salutes.—(1) SALUTES and EYES RIGHT are executed when the commander is 18 paces from the reviewing stand and are terminated when the tail of the staff or platoon is 18 paces beyond. When the unit is marching at the speed of foot troops, this distance is 6 paces.

(2) The following execute and terminate the salute or EYES RIGHT together:

(a) Commander and staff of a group or battalion.

(b) Company commander, second in command, and occupants of their vehicles.

(c) Platoon leader and platoon.

(d) The color guard.

h. At a prescribed point after passing reviewing stand, platoons or larger units leave the field successively as directed in orders for the review.

■ 109. OTHER CEREMONIES.—For details of parades, escorts of the color, escorts of honors, presentation of decorations, decoration of the colors, and funerals, see FM 22-5.

SECTION III

INSPECTIONS

■ 110. GENERAL.—The conduct of inspections is covered in FM 22-5.

■ 111. PREPARATION.—Due to the variety of tank destroyer units and the terrain available, administrative details differ. The field should be laid out carefully and marked. A small advance detail from each battalion is essential for laying out a camp for an inspection.

■ 112. FORMATIONS.—A formation for a full field inspection is shown in figure 45. The distance between companies is 30

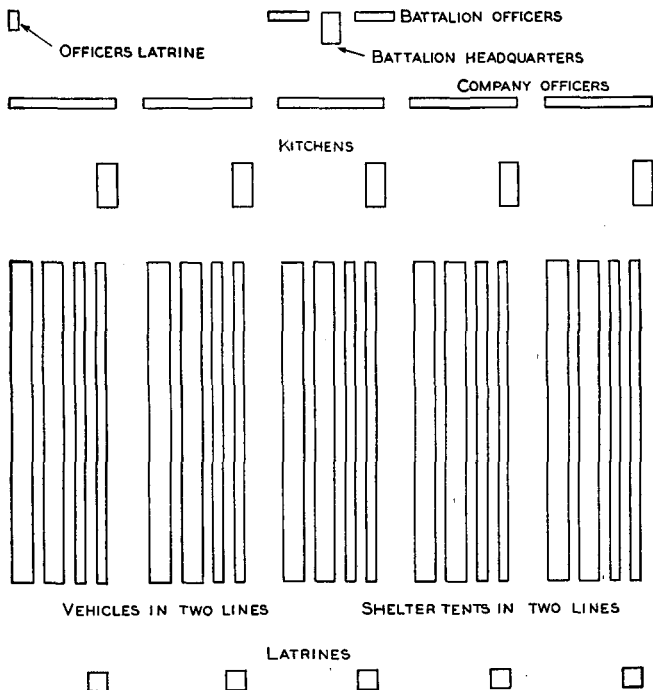

DISTANCES AND INTERVALS ACCORDING TO SPACE AVAILABLE

FIGURE 45.—Tank destroyer battalion. Full field inspection or bivouac.

paces. Shelter tents are pitched 6 paces in front of and facing in the same direction as the vehicles. Officers' tents, kitchens, and latrines are placed as illustrated, distances depending upon the space available.

■ 113. FIELD INSPECTION.—*a.* Vehicular tools are displayed directly in front of vehicles, and equipment boxes are usually opened. Individual equipment is removed from vehicles in case shelter tents are to be pitched.

b. For display of individual equipment see figure 50.

c. Hoods are raised and engine compartments opened.

d. Weapons mounted on vehicles remain on the vehicles; individual weapons are with the men to whom issued.

e. Contents and equipment of trucks are displayed as directed by the commander.

f. For illustration of the display of different types of equipment, see figures 46 to 50 inclusive.

g. Standards are placed in front of the commanding officer's tent and guidons are placed at right front edge of organization commander's tents.

h. The band, if present, forms at the head of the unit and plays during inspection.

i. The inspecting officer should ascertain the state of training of the organization by asking pertinent questions of officers and noncommissioned officers.

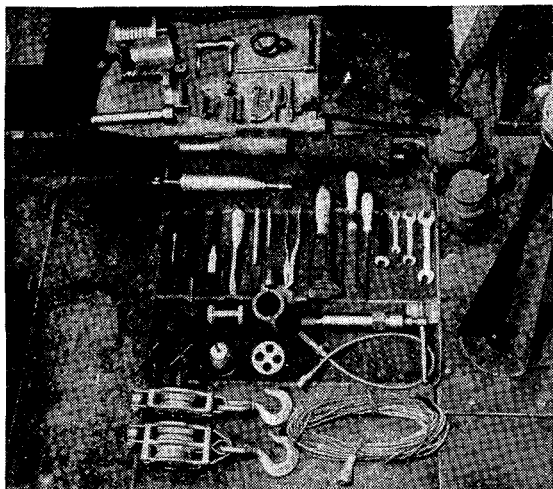

FIGURE 46.—Display of equipment—breech block and gun tools, 75-mm.

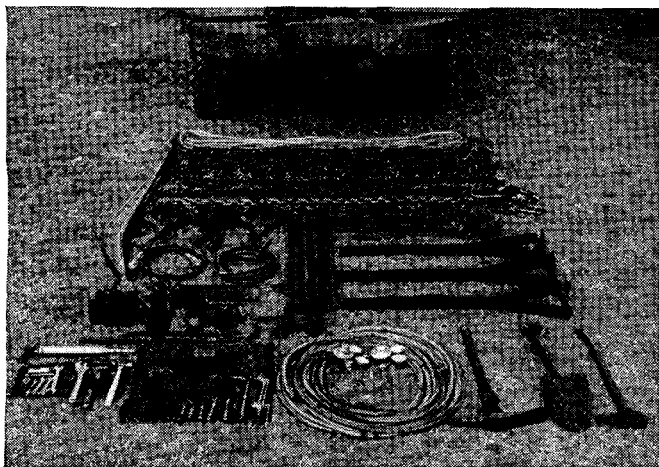

FIGURE 47.—Display of equipment—tools, wrecker truck.

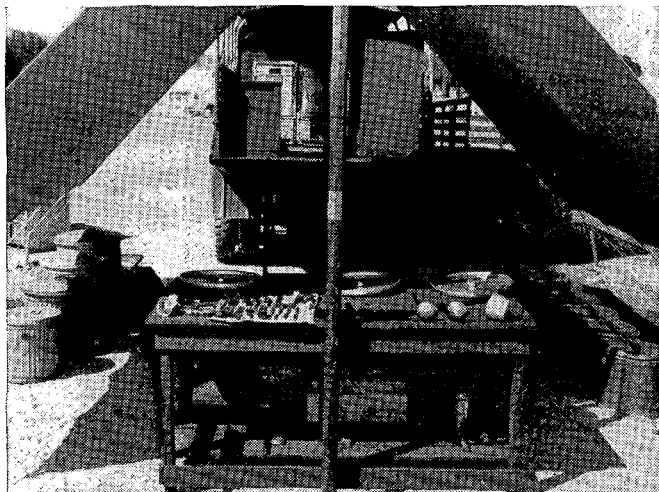

FIGURE 48.—Display of equipment—kitchen.

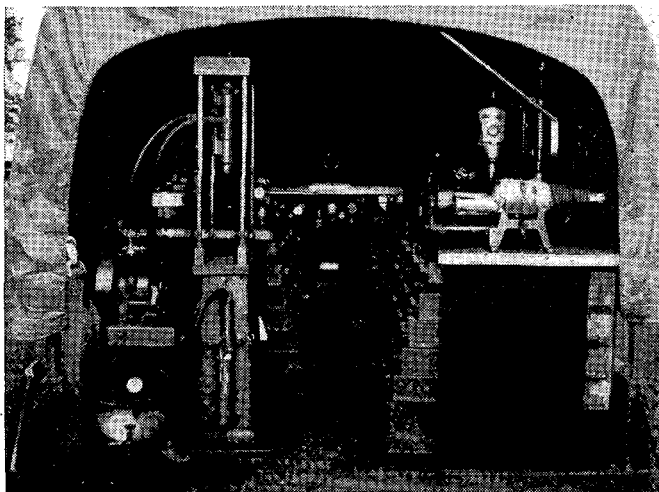

FIGURE 49.—Display of equipment—shop truck.

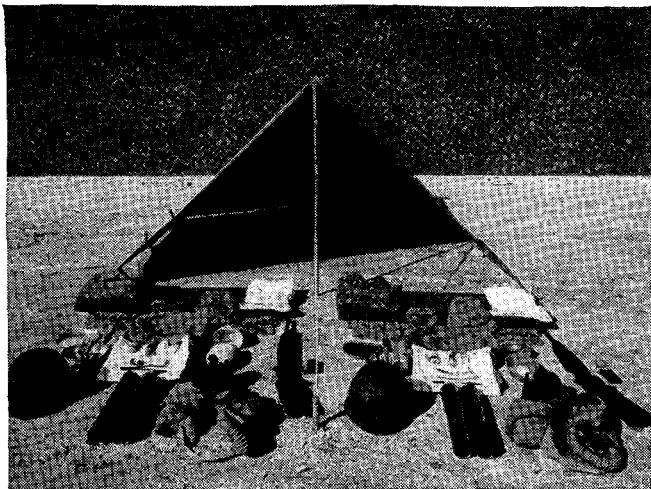

FIGURE 50.—Display of individual equipment.

APPENDIX I

INSPECTION ROUTINE, 76-MM GUN MOTOR CARRIAGE T70

■ 1. GENERAL.—The inspection routine described in this appendix is applicable to the 76-mm gun motor carriage T70. It may be used as a *general guide* for the allocation of duties to crew members in making the inspections prescribed in Technical Manuals pertaining to *specific vehicles*.

■ 2. INSPECTION BEFORE OPERATION.—Radial engines not operated for 30 minutes or more must be turned over by hand at least four complete revolutions.

a. Driver.—(1) Sees that voltmeter reads “zero” (battery switch open).

(2) Closes master battery switch.

(3) Checks to see that fuel tanks are full.

(4) Sees that fuel shut-off valve is open.

(5) Sees that transmission oil gauge shows full. Adds oil, if necessary.

(6) Checks for presence and conditions of fire extinguishers, engine tools, and grousers.

(7) Checks for signs of oil or fuel leaks on floor.

(8) Sees that steering levers, clutch pedal, and gear-shift lever operate freely and over the full range.

(9) Sees that voltmeter reads 13 or more volts (battery switch closed).

(10) Starts engine and, with it operating about 800 rpm, sees that—

(a) Ammeter (with lights off) does not show discharge.

(b) Voltmeter reads between 13 and 15 volts.

(c) Oil pressure gauge registers between 50 and 80 pounds.

(d) Oil temperature gauge (with engine warm) is not less than 190° or over 300° F. (see TM 9-755).

(11) Sees that tachometer indicates 800 rpm of the engine.

(12) Tests magnetos one at a time to insure proper ignition: then, with engine running at 1,800 to 2,000 rpm, turning switch from both to one magneto should drop engine speed not more than 75 to 100 rpm.

(13) Listens for unusual engine noises.

(14) Makes entries pertaining to inspection made by him on vehicle commander's report.

(15) Reports total mileage and total time of engine operation.

(16) Reports to commander when oil temperature is 80° and vehicle is ready. When the air temperature is around freezing or lower, it may be impossible to warm the engine oil to a temperature of 80° by idling. Similarly, when the air temperature is around 90° or higher, the engine oil temperatures may register 180° or higher. It is safe to operate the vehicle under these conditions, provided a check shows that there is no other cause for the engine oil temperature being below 80° or over 180°.

b. Commander.—(1) Inspects—(a) For spots on the ground underneath the vehicle which might be evidence of an oil leak.

(b) That outside accessories (i. e., pioneer tools, tow cable, shackle and shackle pins, etc.) are present, sharp, and in good condition.

(c) The general condition of sprockets, bogies, springs, guides, gudgeons, track supporting rollers, and idlers.

(d) The tracks for wear, tightness, and tension; and connections for wear.

(e) The presence, tightness, and wear of wedges and wedge nuts.

(f) The condition and tightness of grouzers, if used.

(g) For loose air horn connections around top and bottom of air cleaner.

(h) Inspects engine oil level gauge in engine compartment.

(2) The vehicle is moved forward one length and checked for presence, tightness, and wear of inside wedges and wedge nuts.

(3) Causes driver to operate all lights and the horn.

(4) Sees that ammunition, flags or disks, field equipment, and rations, when carried, are properly loaded.

(5) Sees that vehicular weapons are installed, that weapons and mounts function properly.

(6) Tests turret to see if it turns freely and that locking and traversing mechanisms function.

(7) Checks radio and antenna.

(8) Makes entries on commander's report.

(9) Satisfies himself by the sound of the engine and questioning the driver that the vehicle is fully fueled, lubricated, and ready to move out before reporting "Ready" to his immediate superior.

■ 3. INSPECTION AT HALT.—*a. Driver.*—(1) Before stopping engine, tests petcock on transmission for free circulation of oil.

(2) Checks amount of fuel in fuel tanks and reports when supply is low.

(3) Checks transmission oil gauge. Adds oil as necessary.

(4) Reports to the commander any evidence of overheating, defective controls, failure of gauges, or unusual noises not previously noticed.

b. Commander.—(1) Makes the same inspection as made before operation, noting particularly any excessive wear or additional wear on parts not previously noticed and in addition, the following:

(a) For wire, sticks, or other debris in or around sprockets, bogies, tracks, etc., that might interfere with their functioning or cause damage to tracks, and if present, have them removed.

(b) Checks, by feeling, for excessive heat in bogie wheel hubs and idler hubs.

(c) Checks engine compartment for excessive throwing of oil.

(d) Checks level of engine oil in tank for correct amount of oil. Adds oil if necessary.

(2) The vehicle is moved forward one length, if practicable, and checked for presence, tightness, and wear of inside wedges and wedge nuts.

(3) Insures that driver checks oil temperatures and functioning of transmission oil pump.

(4) Reports result of inspection to the platoon leader.

■ 4. INSPECTION AFTER OPERATION.—*a. Driver.*—(1) Refuels.

(2) Opens battery switch.

(3) Closes fuel shut-off valves.

(4) Checks oil level in transmission reservoir and fills to level indicated as FULL on bayonet gauge.

(5) Inspects all control linkage to locate loose or broken parts.

(6) Reports to commander total mileage, total time of engine operation, and total fuel and lubricants used.

b. Commander.—(1) Repeats the same inspection as at the halt.

(2) Inspects electrical wiring for loose connections and abrasions on shielding.

(3) Supervises the driver's preventive maintenance.

(4) Sees that vehicular weapons, ammunition, field, and other equipment, when carried, are unloaded before cleaning vehicle.

(5) Inspects crew compartment to insure that all loose rounds of ammunition and cartridge cases have been removed.

(6) Sees that excessive oil, dirt, and debris are removed from engine compartment.

(7) Checks level of engine oil in tank for correct amount of oil. Adds oil, if necessary.

(8) Insures that vehicle is completely serviced, and that it is cleaned as thoroughly as conditions permit.

(9) Reports ammunition expended and losses or damage of vehicular equipment, accessories, parts, etc., promptly to the platoon leader.

(10) Reports all losses, breakage, or malfunctions of vehicular weapons or parts thereof to the platoon leader.

(11) Makes proper entries in vehicle log book (O. O. Form No. 7255) and Gun Book (O. O. Form No. 5825).

APPENDIX II

DESTRUCTION OF MATÉRIEL

■ 1. GENERAL.—*a.* Tactical situations may arise when, owing to limitations of time or transportation, it will become impossible to evacuate all equipment. In such situations it is imperative that all matériel which cannot be evacuated be destroyed to prevent—

(1) Its capture intact by the enemy.

(2) Its use by the enemy, if captured, against our own or allied troops.

b. The working principles to be followed are:

(1) Methods for the destruction of matériel subject to capture or abandonment in the combat zone must be adequate, uniform, and easily followed in the field.

(2) Destruction must be as complete as the available time, equipment, and personnel will permit. If thorough destruction of all parts cannot be completed, the most important features of the matériel should be destroyed, and parts essential to the operation or use of the matériel and which cannot be easily duplicated should be ruined or removed. The same essential parts must be destroyed on all like units to prevent the enemy's constructing one complete unit from several damaged ones by cannibalization.

(3) The destruction of matériel is a command decision to be implemented only on authority delegated by the division or higher commander.

c. To accomplish adequate and uniform destruction of matériel, it is essential that—

(1) All echelons prepare plans for the destruction of matériel in the event of imminent capture. Such plans must be flexible as to the available time, equipment, and personnel.

(2) All echelons be trained to effect the desired destruction of matériel issued to them. Training will not involve the actual destruction of matériel.

■ 2. METHODS.—*a.* The destruction procedures outlined are arranged in order of effectiveness. Destruction should be accomplished by Method No. 1 if possible. If Method No. 1

cannot be used, destruction should be accomplished by one of the other methods outlined, in the priority shown.

b. Whichever method is used, the sequence outlined should be adhered to. Uniformity of destruction will then be obtained, whether or not the method is carried to completion.

c. Certain of the methods outlined require special tools and materials, such as TNT and grenades, which may not be items of issue normally. The issue of such special tools and material, the vehicles for which issued, and the conditions under which destruction will be effected are command decisions in each case, according to the tactical situation.

■ 3. SMALL ARMS.—*a. Method No. 1.*—(1) *Gun, machine, caliber .30, M1917, M1919A4.*—Field strip. Use barrel as a sledge. Raise cover until vertical, smash cover down toward jacket. Deform and break back plate; deform T-slot. Wedge lock frame, back down, into top of casing between top plate and extractor cam; place chamber end of barrel over lock frame depressors and break off depressors. Insert barrel extension into back of casing, allowing the shank to protrude; knock off shank by striking with the barrel from the side. Deform and crack casing by striking with barrel at side plate corners nearest feedway. Elapsed time: 2½ minutes.

(2) *Gun, machine, caliber, .50, M2, HB or water-cooled.*—Field strip. Use barrel as a sledge. Raise cover; lay bolt in feedway; lower cover on bolt, smash cover down over bolt. Deform back plate. Wedge buffer into rear of casing, allowing depressors to protrude; break off depressors by striking with barrel. Lay barrel extension on its side. Hold down with one foot and break off the shank. Deform casing by striking side plates just back of the feedway. Elapsed time: 3½ minutes.

b. Method No. 2.—Weapons in *a* above: Insert bullet point of complete round into muzzle and bend case slightly, distending mouth of case to permit pulling of bullet. Spill powder from case, retaining sufficient powder to cover bottom of case to a depth of approximately ⅛-inch. Reinsert pulled bullet, point first, back into the case mouth. Chamber and fire this round with the reduced charge. The bullet will stick in the

bore. Chamber one complete round, lay weapon on ground, and fire with a 30-foot lanyard. Use the best available cover, as this means of destruction may be dangerous to the person destroying the weapon. Elapsed time: 2 to 3 minutes.

■ 4. ARTILLERY, SMALLER THAN 57-MM.—*a. Sights.*—Detach all optical sights. If evacuation is possible, carry the sights; if not, thoroughly smash the sights.

b. Method No. 1.—(1) Open drain plug on recoil mechanism, allowing recoil fluid to drain.

(2) Remove and HE shell from a complete round, and seat the shell in the chamber.

(3) Plug the bore for approximately two-thirds of its length, using a ramrod wrapped with cloth or waste to make it fit tightly in the bore. Mud, stones, clay, etc., may be used to plug the bore in lieu of the ramrod.

(4) Cut down a ½-pound TNT block to fit snugly in the chamber behind the HE shell. Insert a tetryl nonelectric cap, with approximately 3 to 4 feet of safety fuze, into the TNT block. Close the breech as far as possible without damaging the safety fuze.

(5) Ignite the safety fuze and take cover at least 100 yards from the gun. Elapsed time: 2 to 3 minutes if ramrod is used to plug bore and cut-down TNT block is carried with gun.

c. Method No. 2.—(1) See *b*(1) above.

(2) See *b*(3) above.

(3) Insert one complete HE round into gun and close breech.

(4) Take cover and fire the gun, using a lanyard 100 feet long. Elapsed time: 1 to 2 minutes if ramrod is used to plug the bore.

d. Method No. 3.—(1) Fire adjacent guns at each other at point-blank range, using HE or AP. Two or more hits from a weapon of the same caliber, on a vital spot such as the breech mechanism, recoil mechanism, or tube should adequately destroy an artillery piece of 75-mm or larger. A greater number of hits will be necessary to destroy cannon of 37-mm to 57-mm by fire from guns of the same caliber. Fire from cover. Danger space is from 200 to 500 yards.

TANK DESTROYER DRILL AND CREW DRILL

(2) Destroy last gun by the best means available.

(3) Danger from cannibalization is inherent to this method.

e. Method No. 4.—(1) See *b(1)* above.

(2) Fire an HE round against a similar round jammed in the muzzle.

f. Method No. 5.—(1) See *b(1)* above.

(2) Disassemble breech mechanism. Use breechblock as a sledge and deform parts which have been removed. Remove coupling key and deform. Elapsed time: *1 minute*.

■ 5. ARTILLERY, 57-MM AND LARGER.—*a. Sights.*—See paragraph *4a*.

b. Method No. 1.—(1) See paragraph *4b(1)*.

(2) Place an armed (safety pin removed) M9A1 antitank grenade, HE, or armed (safety pin removed) M6 antitank rocket in the tube about 6 inches in front of, and with the ogive nose end toward the HE shell in (3) below.

(3) Insert an unfuzed HE complete round into the cannon and close the breech.

(4) Fire the cannon, using a lanyard at least 100 feet long. The person firing should be under cover to the rear of the piece and approximately 20° off the line of fire. Elapsed time: *2 to 3 minutes*.

(5) The danger zone is approximately 200 yards.

c. Method No. 2.—(1) See paragraph *4b(1)*.

(2) Fire an HE round, assembled with a point detonating fuze, against a similar round jammed in the muzzle. A lanyard at least 100 feet long should be used and the firer should be under cover as the danger zone is approximately 200 yards. Elapsed time: *2 to 3 minutes*.

d. Method No. 3.—(1) Insert TNT blocks in the bore near the muzzle and in the chamber of the cannon. Close the breechblock as far as possible without damaging the safety fuze. Plug the muzzle tightly with earth to a distance of approximately three calibers from muzzle. Detonate the TNT charges simultaneously.

(2) The following number of ½-pound TNT blocks will be needed for effective demolition: 57-mm to 3-inch cannon in bore, two to three blocks, and in chamber, four to six

blocks. The cardboard cases on the blocks should be removed.

e. Method No. 4.—See paragraph 4*d*.

f. Method No. 5.—See paragraph 4*f*.

■ **6. VEHICLES.**—*a. Method No. 1.*—(1) Remove and empty portable fire extinguishers. Puncture the fuel tanks if readily accessible. Place TNT charges as indicated in the table below and insert tetryl nonelectric caps with at least 5 feet of safety fuze in each charge. Ignite the fuzes and take cover. Elapsed time: 1 to 2 minutes, if charges are prepared beforehand and carried in the vehicle.

| Vehicle | TNT charge, pounds | Placed |
|------------------------------|--------------------|---|
| M10 destroyer (2 charges) | 3 | Between engine oil cooler and right fuel tank. |
| | 2 | Under left side of transmission as far forward as possible. |
| T70 destroyer (2 charges) | 3 | On floor to left of assistant driver and underneath transmission housing. |
| | 3 | In turret between starter and air cleaner. |
| Half-tracks, all (2 charges) | 2 | Over clutch housing at rear of cylinder block. |
| | 1 | On left side of engine as low as possible. |
| Trucks (2 charges) | 2 | On top of clutch housing. |
| | 2 | On left side of engine as low as possible. |
| Trailers | 2 | Over axle inside each wheel. |
| Other vehicles | 2 | On top of clutch housing. |

(2) If sufficient time and materials are available, additional destruction of track-laying vehicles may be accomplished by placing a 2-pound TNT charge at about the center of each track assembly. Detonate these charges in the same manner as the others.

(3) If charges are prepared beforehand and carried in the vehicle, keep the caps and fuzes separated from the charges until used.

b. Method No. 2.—(1) Remove and empty the portable fire extinguishers. Puncture the fuel tanks, if readily accessible.

Open all doors and hatches if time is available. Fire on the vehicle, using adjacent tanks, antitank or other artillery, or antitank rockets or grenades. Aim at the engine, suspension, and armament in the order named. If a good fire is started, the vehicle may be considered destroyed. Elapsed time: *about 5 minutes per vehicle.*

(2) Destroy the last remaining vehicle by the best means available.

c. Method No. 3.—Remove and empty the portable fire extinguishers. Puncture the fuel tanks, if readily accessible. Smash all vital elements such as distributor, carburetor, radiator, engine block, air and oil cleaners, generator, control levers, crankcase, and transmission with an ax, pick, or sledge. Pour gasoline, oil, or distillate over entire unit and ignite.

■ 7. PNEUMATIC TIRES.—*a. General.*—(1) Rubber is such a critical item that whenever matériel is subject to capture or abandonment, an attempt to destroy pneumatic tires must always be made, even if time will not permit destruction of the remainder of the vehicle.

(2) With adequate planning and training the destruction of tires may be accomplished in conjunction with destruction of the vehicle without increasing the time necessary.

b. Method No. 1.—(1) Ignite an M14 incendiary grenade under each tire.

(2) Insure the best results when this method is combined with destruction by TNT by seeing that incendiary fires are well started before detonating the TNT.

c. Method No. 2.—(1) Damage the tires with an ax, pick, or machine-gun fire, the tires being deflated if possible. Pour gasoline on tires, dousing each one, and ignite.

(2) When used in conjunction with wheeled vehicle destruction, the ensuing fire will adequately destroy the vehicle.

■ 8. AMMUNITION.—*a. General.*—(1) Time will not usually permit the destruction of all ammunition in forward combat zones.

(2) When sufficient time and materials are available, ammunition may be destroyed as indicated below. At least 30 to 60 minutes will be required to destroy adequately the ammunition carried by combat units.

b. Unpacked complete round ammunition.—(1) Stack ammunition in small piles. Small arms ammunition may be heaped. Stack or pile most of the available gasoline in cans and drums around the ammunition. Throw onto the pile all available inflammable material such as rags, scrap wood, and brush. Pour the remaining available gasoline over the pile. Sufficient inflammable material must be used to insure a very hot fire. Ignite the gasoline and take cover.

(2) Ammunition of 37-mm or larger caliber can be destroyed by sympathetic detonation, using TNT. Pile the ammunition in two stacks, about 3 inches apart, with the fuzes in each stack toward each other. Place TNT charges between the stacks. Use a minimum of 1 pound of TNT per 10 rounds of 37-mm or per 4 to 5 rounds of 75-mm or 3-inch ammunition. Detonate all TNT charges simultaneously from cover.

c. Packed complete round ammunition.—Stack the boxes or bundled ammunition in small piles. Cover with all available inflammable materials, such as rags, scrap wood, brush, and gasoline in drums or cans. Pour gasoline over the pile. Ignite the gasoline and take cover. Small-arms ammunition must be broken out of the boxes or cartons before burning.

d. Miscellaneous.—(1) Grenades, antitank mines, bombs, and mortar ammunition may be destroyed by the methods outlined in *b* and *c* above. The amount of TNT necessary is considerably less, due to the larger percentage of explosives in the grenades, mines, etc., compared with the artillery shell.

(2) Fuzes, boosters, detonators, pyrotechnics, and similar material should be destroyed by burning.

■ 9. FIRE-CONTROL EQUIPMENT.—*a.* All fire-control equipment, including optical sights and binoculars, is difficult to replace. It should be the last equipment to be destroyed, if there is any chance of personnel being able to evacuate. If evacuation of personnel is made, all possible items of fire-

control equipment should be carried. If evacuation of personnel is not possible, fire-control equipment must be thoroughly destroyed.

b. Firing tables, charts, slide rules, and similar items should be thoroughly burned.

c. All optical equipment will be thoroughly smashed.

■ 10. SIGNAL COMMUNICATION MATÉRIEL.—*a. General.*—(1) Unclassified communication equipment will be destroyed beyond possibility of repair or reclamation of parts.

(2) Secret and confidential communication equipment, codes, ciphers, cipher devices, and instruction books will be destroyed beyond recognition. Personnel who are responsible for secret or confidential equipment must be familiar with any special or detailed instructions relating to any particular device and must be prepared at all times to carry out those instructions without delay.

b. Priority of destruction.—(1) Parts which are nonstandard and unusual, either from a mechanical or electrical standpoint, since the likelihood that the enemy can replace them would be small, particularly if all captured units of a particular item have the same nonstandard component destroyed.

(2) Critical units, since the likelihood that the enemy would be able to replace them would be smaller than for noncritical items.

(3) Parts interchangeable with other equipment, to prevent the enemy from using them to salvage other types of destroyed equipment.

(4) Other parts.

c. Methods.—(1) Instruction books, circuit and wiring diagrams, records of all kinds, code books, and registered documents will be destroyed by burning. Each cryptographic security officer will secure a 5-gallon can of gasoline to be kept within easy reach and close proximity to the storage place of all registered documents. If possible, each document will be separated into individual sheets, each sheet crumpled, and all placed in a pile. The pile may then be saturated with gasoline and ignited.

(2) Radio sets may be destroyed by explosives or by wrecking. Shear off all panel knobs and dials, break open set compartment by smashing in panel face and knocking off top and sides. Destroy all tubes and circuit elements, smash coils, crystals, microphones, earphones, and batteries. The variable gang tuning condenser is the most difficult part to replace and will be destroyed.

(3) Pile up equipment already smashed, and pour on gasoline or oil and ignite.

■ 11. TRAINING.—*a.* All training schedules will include instruction in the methods of destruction of matériel outlined in this appendix. All personnel will be familiarized with both hasty and deliberate methods.

b. During drills in destruction of matériel, care will be exercised that matériel and equipment are not damaged.

c. Additional information on this subject will be found in Training Circular No. 63, War Department, 1942, and Training Circular No. 5, War Department, 1943.

INDEX

| | Paragraph | Page |
|---|------------------------------------|---------------------------------------|
| Action, dismounted----- | 54 | 57 |
| Advanced training: | | |
| Crew----- | 12 | 23 |
| Weapons----- | 7 | 14 |
| Aircraft, fire against----- | 15, 61 | 24, 54 |
| Antiaircraft: | | |
| Firing----- | 61 | 54 |
| Firing positions----- | 15 | 24 |
| Machine-gun mounts----- | 57 | 62 |
| Machine-gun ground mount----- | 63 | 68 |
| Band----- | 113 | 112 |
| Battalion, tank destroyer, extended formations---- | 95 | 94 |
| Breechblock, 3-inch gun----- | 19 | 28 |
| Call off----- | 24, 38, 68 | 31, 42, 70 |
| Camouflage----- | 16 | 25 |
| Care of matériel----- | 20 | 30 |
| Ceremonies: | | |
| Details of other----- | 109 | 110 |
| Dismounted----- | 97 | 101 |
| Field review----- | 100 | 104 |
| Initial formations----- | 106 | 106 |
| Music at----- | 105 | 105 |
| Purpose----- | 96 | 101 |
| Road review----- | 99 | 102 |
| Salute----- | 108 | 106 |
| Commander: | | |
| Battalion----- | 99 | 102 |
| Company----- | 99 | 102 |
| Destroyer----- | 22, 41, 42, 45, 46, 47, 51, 52, 67 | 30, 42, 48, 50, 52, 54, 55, 70. |
| Of troops----- | 101, 108 | 104, 106 |
| Commands----- | 3 | 2 |
| Company, battalion headquarters, extended formation----- | 95 | 94 |
| Company, reconnaissance, extended formation---- | 95 | 94 |
| Company, tank destroyer, extended formation---- | 95 | 94 |
| Company wedge----- | 95 | 94 |
| Composition, 3-inch destroyer squad----- | 22, 67 | 30, 70 |
| Concealment----- | 14 | 23 |
| Cover----- | 14 | 23 |
| Crew: | | |
| Advanced training----- | 11 | |
| Composition----- | 22, 36, 67 | 30, 41, 70 |
| Concealment----- | 14 | 23 |
| Instruction----- | 8 | 14 |
| Leader----- | 14 | 23 |
| Teamwork----- | 8 | 14 |
| To dismount----- | 41 | 42 |
| To form----- | 23, 37, 67 | 31, 41, 70 |

INDEX

| | Paragraph | Page |
|--------------------------------------|------------------------|-----------------------|
| Crew—Continued. | | |
| To post..... | 25, 39, 70 | 31, 42, 71 |
| Training..... | 7 | 14 |
| Definitions..... | 2, 9 | 2, 14 |
| Description of— | | |
| 76-mm gun motor carriage T70..... | 34 | 41 |
| 3-inch gun motor carriage M10..... | 19 | 28 |
| Destroyer: | | |
| Firing position..... | 14 | 23 |
| Crew..... | 22 | 30 |
| To change locality of..... | 50 | 54 |
| Destruction of matériel..... | App. II | 120 |
| Detachment, battalion, medical..... | 95 | 94 |
| Drill: | | |
| Dismounted..... | 96 | 101 |
| Regulations..... | 1 | 1 |
| Driving, in formation..... | 99 | 102 |
| Duties: | | |
| After firing..... | 52 | 55 |
| Detailed description..... | 29, 30, 46, 53 | 35, 50, 55 |
| During firing..... | 31, 45, 85 | 37, 50, 84 |
| During marches..... | 27, 43 | 34, 50 |
| Elevating mechanism, 3-inch gun..... | 19 | 28 |
| Emplacement, gun..... | 14, 16 | 23, 25 |
| Enfilading fire..... | 14 | 23 |
| Equipment: | | |
| Display of..... | 113 | 112 |
| Examine..... | 59 | 66 |
| Estimation, range..... | 10 | 17 |
| Field of fire: | | |
| Antiaircraft..... | 15 | 24 |
| Clear..... | 16 | 25 |
| Destroyer..... | 14 | 23 |
| Field inspection..... | 113 | 23 |
| Field review: | | |
| Composition..... | 100 | 104 |
| Preparation for..... | 102 | 104 |
| Fire: | | |
| Enfilading..... | 14 | 23 |
| Field of..... | 15 | 24 |
| Flanking..... | 14 | 23 |
| Orders..... | 9 | 14 |
| Fire control..... | 9 | 14 |
| Firing: | | |
| At ground targets..... | 62 | 68 |
| Duties during..... | 29, 30, 31, 46, 47, 85 | 35, 37, 50, 52, 84 |
| Duties after..... | 52 | 55 |
| Mechanism, 3-inch gun..... | 19 | 28 |
| Firing positions: | | |
| Antiaircraft..... | 15 | 24 |
| Destroyer..... | 14 | 23 |
| Flanking fire..... | 14 | 23 |
| Flag signals..... | 6 | 3 |

INDEX

| | Paragraph | Page |
|--------------------------------------|------------------------|--------------------|
| Formation: | | |
| Combat..... | 95 | 94 |
| Drill..... | 1 | 1 |
| Headquarters company..... | 95 | 94 |
| Initial..... | 106 | 106 |
| Inspection..... | 112 | 111 |
| Medical detachment..... | 95 | 94 |
| Pioneer platoon..... | 95 | 94 |
| Reconnaissance platoon..... | 95 | 94 |
| Reconnaissance section..... | 95 | 94 |
| Road review..... | 99 | 102 |
| Tank destroyer company..... | 95 | 94 |
| Tank destroyer platoon..... | 95 | 94 |
| Forming the crew..... | 23 | 31 |
| Frontal fire..... | 14 | 23 |
| Guidons, positions of..... | 103, 113 | 104, 112 |
| Gun: | | |
| Antiaircraft..... | 15 | 24 |
| Description, 3-inch..... | 19 | 28 |
| Emplacement..... | 14 | 23 |
| Machine..... | 15, 56 | 24, 62 |
| Motor carriage, 3-inch, M10..... | 19 | 28 |
| To fire, 3-inch gun..... | 29 | 35 |
| 3-inch..... | 19 | 28 |
| 3-inch towed..... | 64 | 69 |
| Gunner, T70..... | 41, 42, 45, 46, 47, 52 | 42, 48, 50, 52, 55 |
| Gun motor carriage: | | |
| T70..... | 34 | 41 |
| 3-inch, M10..... | 19 | 28 |
| Instruction, crew..... | 8 | 14 |
| Instrument, range..... | 10 | 17 |
| Inspection: | | |
| T70..... | 55 | 58 |
| 3-inch gun..... | 20 | 30 |
| Formal..... | 109 | 110 |
| Formations..... | 112 | 111 |
| Field..... | 113 | 112 |
| Preparation for..... | 111 | 111 |
| Intervals..... | 108 | 106 |
| Interphone..... | 4, 55 | 2, 58 |
| Initial, formations..... | 106 | 106 |
| Lubricating, 3-inch gun..... | 20 | 30 |
| Machine gun..... | 15, 56 | 24, 62 |
| Marches..... | 27 | 34 |
| March order..... | 9, 33, 51 | 14, 39, 54 |
| March in review..... | 108 | 106 |
| Matériel: | | |
| Care and maintenance of..... | 20, 98 | 30, 101 |
| Destruction of..... | App. II | 120 |
| Maintenance: | | |
| Of Matériel..... | 20 | 30 |
| Training..... | 20 | 30 |
| Malfunctions, 3-inch gun..... | 20 | 30 |

INDEX

| | Paragraph | Page |
|--|------------|------------|
| Mechanical training: | | |
| 3-inch gun..... | 18, 20 | 28, 30 |
| Antiaircraft machine gun..... | 56 | 62 |
| Mechanism: | | |
| Elevating, 3-inch gun..... | 19 | 28 |
| Recoil, 3-inch gun..... | 19 | 28 |
| Traversing, 3-inch gun..... | 19 | 28 |
| Medical detachment..... | 95 | 94 |
| Mil conversion tables..... | 10 | 17 |
| Motorcycle, in review..... | 99, 106 | 102, 106 |
| Mounted reviews, rules for..... | 103 | 104 |
| Music..... | 113 | 112 |
| Mutual support..... | 14 | 23 |
| Muzzle blast..... | 16 | 25 |
| Obstacles..... | 14 | 23 |
| Officer: | | |
| Passing in review..... | 103 | 104 |
| Reviewing..... | 99 | 102 |
| Other ceremonies..... | 109 | 110 |
| Parades (<i>see also</i> Ceremonies)..... | 96 | 101 |
| Pass in review..... | 108 | 106 |
| Position: | | |
| Alternate..... | 14, 50 | 23, 54 |
| Antiaircraft firing..... | 15 | 24 |
| Destroyer firing..... | 14 | 23 |
| Occupation and organization of..... | 16 | 25 |
| Reconnaissance for..... | 13 | 23 |
| Routes to..... | 14 | 23 |
| Supplementary..... | 14, 50 | 23, 54 |
| To change..... | 32 | 38 |
| Posts, crews..... | 25, 39, 70 | 31, 42, 71 |
| Prepare for action..... | 9, 26, 42 | 14, 32, 48 |
| Preparation for inspection..... | 111 | 111 |
| Radio..... | 55 | 58 |
| Range estimation..... | 10 | 17 |
| Recoil mechanism, 3-inch gun..... | 19 | 28 |
| Reconnaissance, for position..... | 13 | 23 |
| Reviews: | | |
| Field..... | 100 | 104 |
| March in..... | 108 | 106 |
| Mounted..... | 103 | 104 |
| Preparation for..... | 102 | 104 |
| Purpose..... | 98 | 101 |
| Road..... | 99 | 102 |
| Rules..... | 103 | 104 |
| Reviewing officer..... | 99, 108 | 102, 106 |
| Reviewing party..... | 107 | 106 |
| Reviewing stand..... | 102 | 104 |
| Road review..... | 99 | 102 |
| Routes, covered..... | 14 | 23 |
| Salutes..... | 108 | 106 |
| Scope..... | 1, 35 | 1, 41 |
| Sensing..... | 9 | 14 |

INDEX

| Signals: | Paragraph | Page |
|---|-----------|----------|
| Arm and hand----- | 6 | 3 |
| Audible----- | 3, 4 | 2 |
| Disk----- | 6 | 3 |
| Flag----- | 6 | 3 |
| Touch----- | 5 | 3 |
| Command----- | 6 | 3 |
| Driver's----- | 6 | 3 |
| Guide----- | 6 | 3 |
| Light----- | 6 | 3 |
| Visual----- | 6, 8 | 3, 14 |
| Slopes, gun position----- | 14 | 23 |
| Squad. (See crew.) | | |
| Standards----- | 99, 104 | 102, 105 |
| Support, mutual----- | 14 | 23 |
| Tables, mil conversion----- | 10 | 17 |
| Terms----- | 9 | 14 |
| Terrain, use of----- | 12, 13 | 23 |
| To change firing position----- | 32 | 38 |
| To change locality of destroyer----- | 32 | 38 |
| To close breech, 3-inch gun----- | 19 | 28 |
| To examine equipment----- | 59 | 66 |
| To form the crew: | | |
| T70----- | 41 | 42 |
| 3-inch destroyer----- | 23 | 31 |
| To load 3-inch gun----- | 19 | 28 |
| To open 3-inch breech----- | 19 | 28 |
| To return to march order----- | 33 | 39 |
| To traverse 3-inch gun----- | 19 | 28 |
| To unload 3-inch gun----- | 19 | 28 |
| Training: | | |
| Antiaircraft machine gun----- | 56 | 62 |
| Crew----- | 7 | 14 |
| Driver----- | 20 | 30 |
| Maintenance----- | 7, 20 | 14, 30 |
| Position occupation----- | 16 | 25 |
| Team play----- | 8 | 14 |
| 3-inch gun crew----- | 21 | 30 |
| Track-laying vehicle, inspection routine----- | App. I | 116 |
| Traversing mechanism, 3-inch gun----- | 19 | 28 |
| Trenches----- | 16 | 25 |
| Troops, commander of----- | 101, 108 | 104, 106 |
| Uneven ground----- | 14 | 23 |
| Weapons: | | |
| Advanced training----- | 7 | 14 |
| Definitions----- | 9 | 14 |
| Elementary training----- | 7 | 14 |
| General----- | 8 | 14 |
| In view----- | 103 | 104 |
| Purpose and scope----- | 7 | 14 |

